

## Unterflur-Bodendose UBD 160 aus Chromstahl

---

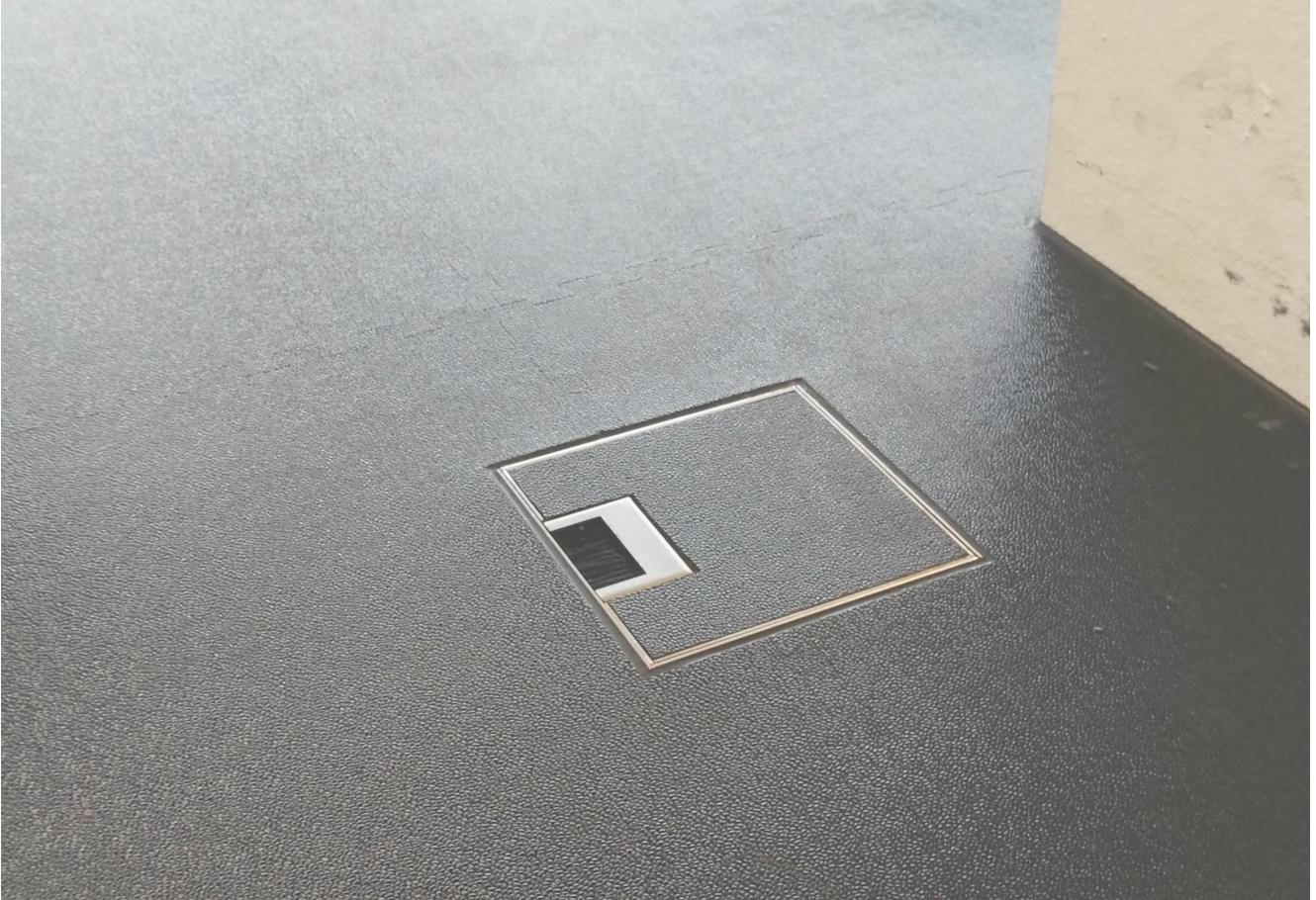

- Minimaler Bodenaufbau ab 108mm mit 5mm Vertiefung im Deckel (Isolation + Unterlagsboden + Bodenbelag)
- Mit innenliegenden Nivellierschrauben
- Rahmen, Deckel mit Kante, Auslass und Steckdoseneinsatz aus Chromstahl
- Unterteil, Deckel flach und Nivellierschrauben aus SVZ (sendzimir-verzinkter Stahl)

	Kunststoff-Einbaubox, schwarz, halogenfrei (siehe Datenblatt) oben: 170/170mm unten: 260/310mm H: 185mm
	<b>UBD 160 198</b>

	Trittschall-Unterlage 3mm, für Einbaubox
	Set à 4 Stk. <b>UBD 001 002</b>

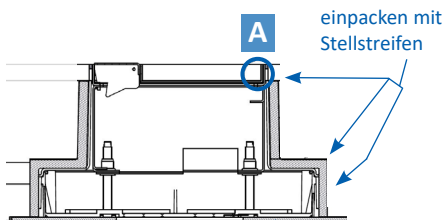
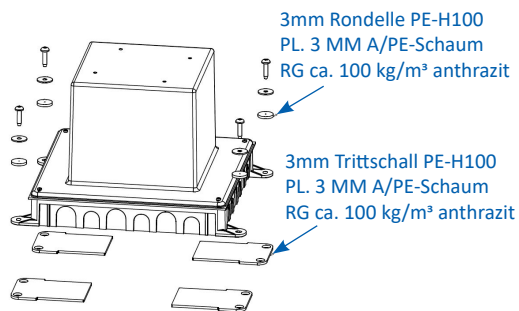

Einbaubox aufliegend WW auf 3mm Trittschall PE-H100 PL. 3 MM A/PE-Schaum, RG ca. 100 kg/m<sup>3</sup> anthrazit

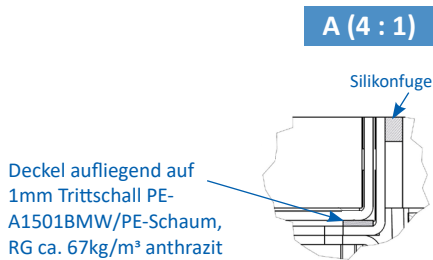

	Aufstock-Rahmen aus SVZ inkl. Nivellierschrauben zu UBD 160 und 210
	<b>UBD 160 210</b> bis 90mm, mit EBB: bis 270mm
<b>UBD 160 211</b>	bis 165mm, mit EBB: bis 345mm

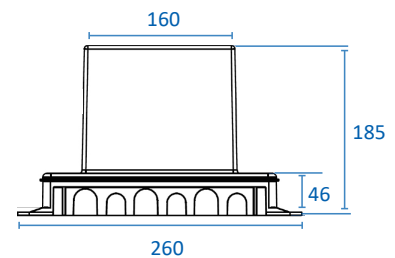

**Details UBD 160 210**

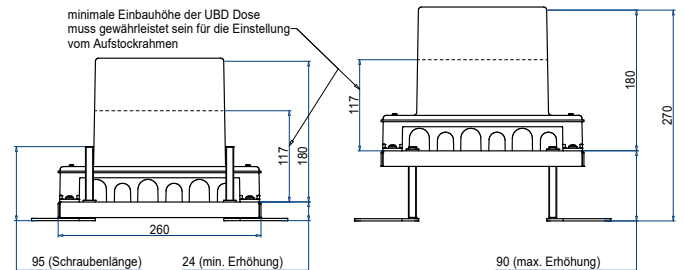

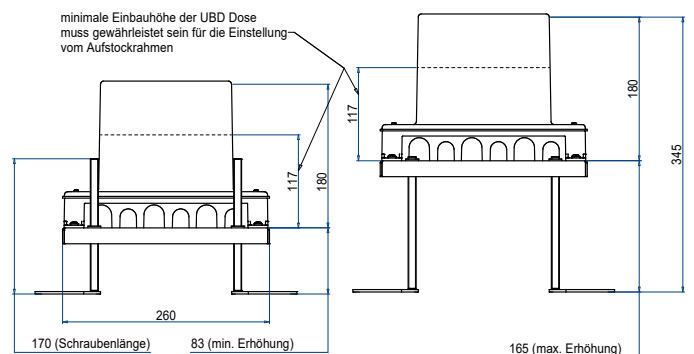

**Details UBD 160 211**



## mit 15mm Vertiefung

	Unterflur-Bodendose UBD 160 aus Chromstahl inkl. Deckel mit Kante, geschlossen, 15mm Vertiefung und 1 Schnurauslass
<b>UBD 160 155</b>	

	Unterflur-Bodendose UBD 160 aus Chromstahl inkl. Deckel mit Kante, geschlossen, 15mm Vertiefung und 1 Bürstenauslass
<b>UBD 160 156</b>	

	Unterflur-Bodendose UBD 160 aus Chromstahl inkl. Blinddeckel mit Kante, geschlossen, und 15mm Vertiefung
<b>UBD 160 159</b>	

	Nivellierschrauben, Set à 4 Stk.
	Nivellierbereich von Roh- bis Fertigboden
<b>UBD 001 070</b>	116 - 161mm
<b>UBD 001 095</b>	128 - 186mm
<b>UBD 001 120</b>	153 - 211mm

## Chromstahl geschliffen

	Unterflur-Bodendose UBD 160 aus Chromstahl inkl. belegtem Deckel und 1 Schnurauslass
<b>UBD 160 157</b>	

	Unterflur-Bodendose UBD 160 aus Chromstahl inkl. belegtem Deckel und 1 Bürstenauslass
<b>UBD 160 158</b>	

	Unterflur-Bodendose UBD 160 aus Chromstahl inkl. belegtem Blinddeckel
<b>UBD 160 153</b>	

	Nivellierschrauben, Set à 4 Stk.
	Nivellierbereich von Roh- bis Fertigboden
<b>UBD 001 070</b>	116 - 161mm
<b>UBD 001 095</b>	128 - 186mm
<b>UBD 001 120</b>	153 - 211mm



## mit 5mm Vertiefung

	Unterflur-Bodendose UBD 160 aus Chromstahl inkl. Deckel, flach (SVZ), ohne Kante, 5mm Vertiefung und 1 Schnurauslass
<b>UBD 162 051</b>	

	Unterflur-Bodendose UBD 160 aus Chromstahl inkl. Deckel, flach (SVZ), ohne Kante, 5mm Vertiefung und 1 Bürstenauslass
<b>UBD 162 052</b>	

	Nivellierschrauben, Set à 4 Stk.
	Nivellierbereich von Roh- bis Fertigboden
<b>UBD 001 070</b>	108 - 153mm
<b>UBD 001 095</b>	120 - 178mm
<b>UBD 001 120</b>	145 - 203mm

## mit 20mm Vertiefung

	Unterflur-Bodendose UBD 160 aus Chromstahl inkl. Deckel mit Kante, geschlossen, 20mm Vertiefung und 1 Schnurauslass
<b>UBD 162 201</b>	

	Unterflur-Bodendose UBD 160 aus Chromstahl inkl. Deckel mit Kante, geschlossen, 20mm Vertiefung und 1 Bürstenauslass
<b>UBD 162 202</b>	

	Nivellierschrauben, Set à 4 Stk.
	Nivellierbereich von Roh- bis Fertigboden
<b>UBD 001 070</b>	121 - 166mm
<b>UBD 001 095</b>	133 - 191mm
<b>UBD 001 120</b>	158 - 216mm

## mit 25mm Vertiefung

	Unterflur-Bodendose UBD 160 aus Chromstahl inkl. Deckel mit Kante, geschlossen, 25mm Vertiefung und 1 Schnurauslass
<b>UBD 162 251</b>	

	Unterflur-Bodendose UBD 160 aus Chromstahl inkl. Deckel mit Kante, geschlossen, 25mm Vertiefung und 1 Bürstenauslass
<b>UBD 162 252</b>	

	Nivellierschrauben, Set à 4 Stk.
	Nivellierbereich von Roh- bis Fertigboden
<b>UBD 001 070</b>	126 - 171mm
<b>UBD 001 095</b>	138 - 196mm
<b>UBD 001 120</b>	163 - 221mm

## mit 30mm Vertiefung

	Unterflur-Bodendose UBD 160 aus Chromstahl inkl. Deckel mit Kante, geschlossen, 30mm Vertiefung und 1 Schnurauslass
<b>UBD 162 301</b>	

	Unterflur-Bodendose UBD 160 aus Chromstahl inkl. Deckel mit Kante, geschlossen, 30mm Vertiefung und 1 Bürstenauslass
<b>UBD 162 302</b>	

	Nivellierschrauben, Set à 4 Stk.
	Nivellierbereich von Roh- bis Fertigboden
<b>UBD 001 070</b>	131 - 176mm
<b>UBD 001 095</b>	143 - 201mm
<b>UBD 001 120</b>	168 - 226mm

## Schwerlast-Bodendose

	Schwerlast-Unterflur-Bodendose UBD 160 aus Chromstahl inkl. Deckel mit Kante, geschlossen, 4mm Verstärkungsplatte, 16mm Vertiefung und 1 Schnurauslass
<b>UBD 162 161</b>	

	Schwerlast-Unterflur-Bodendose UBD 160 aus Chromstahl inkl. Deckel mit Kante, geschlossen, 4mm Verstärkungsplatte, 16mm Vertiefung und 1 Bürstenauslass
<b>UBD 162 162</b>	

	Schwerlast-Unterflur-Bodendose UBD 160 aus Chromstahl inkl. belegtem Deckel, 4mm Verstärkungsplatte und 1 Bürstenauslass
<b>UBD 162 163</b>	

	Nivellierschrauben, Set à 4 Stk.
	Nivellierbereich von Roh- bis Fertigboden
<b>UBD 001 070</b>	121 - 166mm
<b>UBD 001 095</b>	133 - 191mm
<b>UBD 001 120</b>	158 - 216mm

## ohne Schutzkante

	Unterflur-Bodendose UBD 160 aus Chromstahl inkl. belegtem Deckel aus 4mm SVZ, ohne Schutzkante, mit Ausschnitt
<b>UBD 162 001</b>	

	Nivellierschrauben, Set à 4 Stk.
	Nivellierbereich von Roh- bis Unterlagsboden
<b>UBD 001 070</b>	103 - 148mm
<b>UBD 001 095</b>	115 - 173mm
<b>UBD 001 120</b>	140 - 198mm

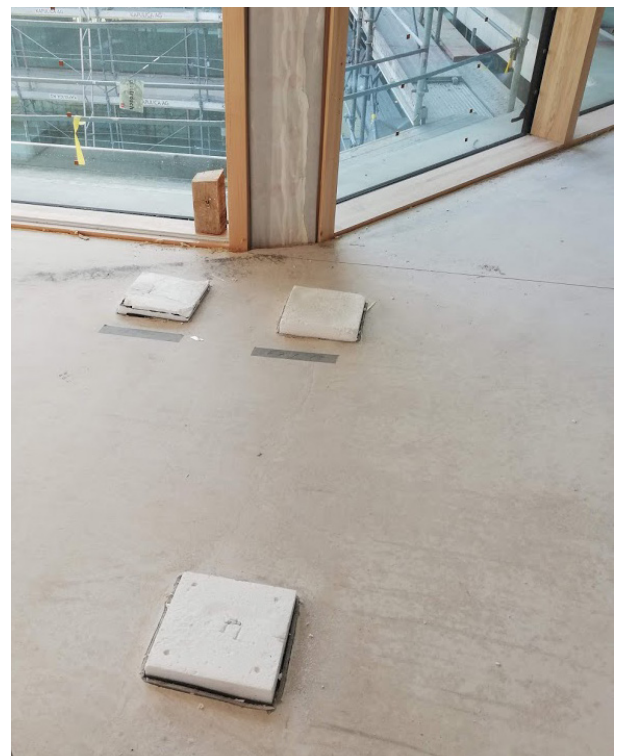
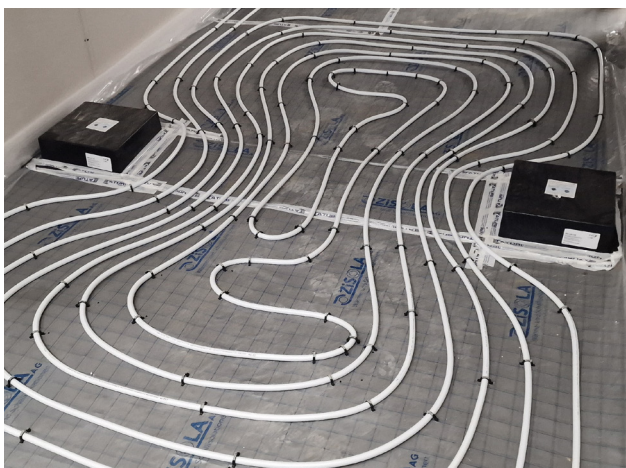

## Beispiele Bestückung



1xT13 weiss + 1xT13 schwarz  
+ 2xRJ45 + TV

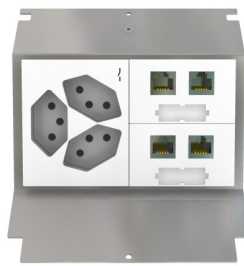

3xT13/s + 2x 2xRJ45



3xT13/s + 2xRJ45 + TV

## Steckdoseneinsatz für 4 FLF

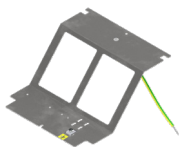

Steckdoseneinsatz für 4 FLF inkl.  
Erddraht, leer

**UBD 160 165**

## Modul 45x45



Steckdoseneinsatz mit 3x 45x45-  
und 4x MH-Ausschnitten, leer

**UBD 160 150**

**CMD 100 001, MH Blinddeckel**

**CMD 100 003, MH Keystone**

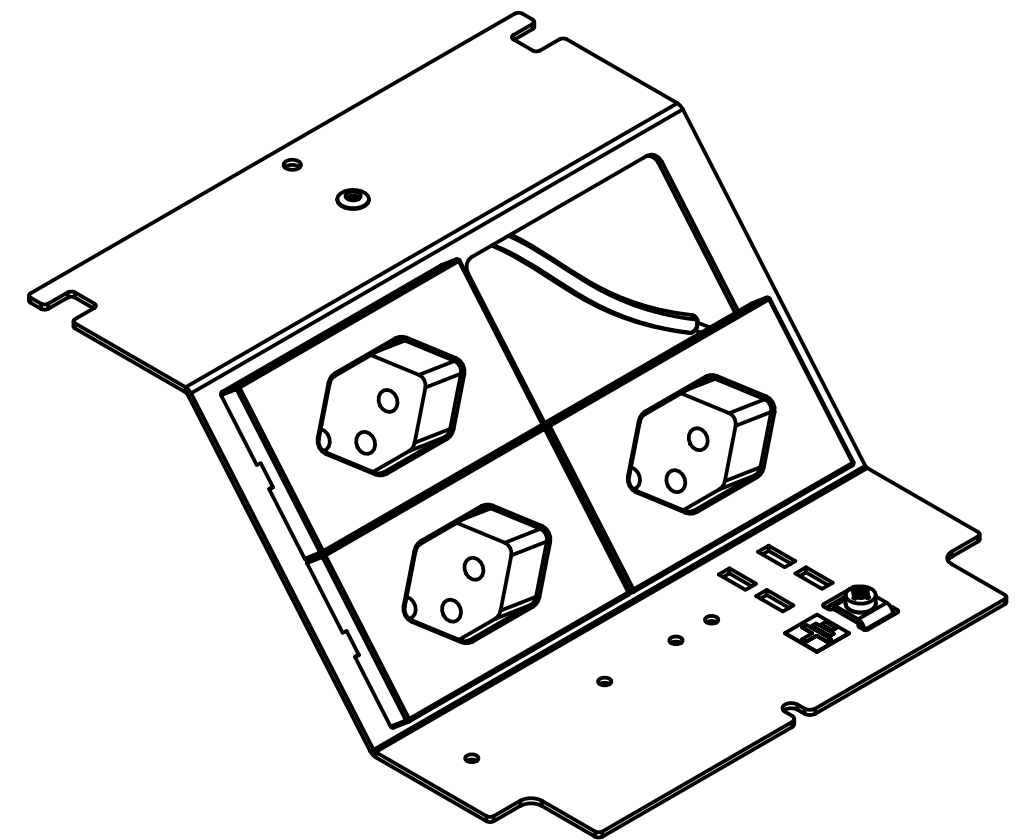
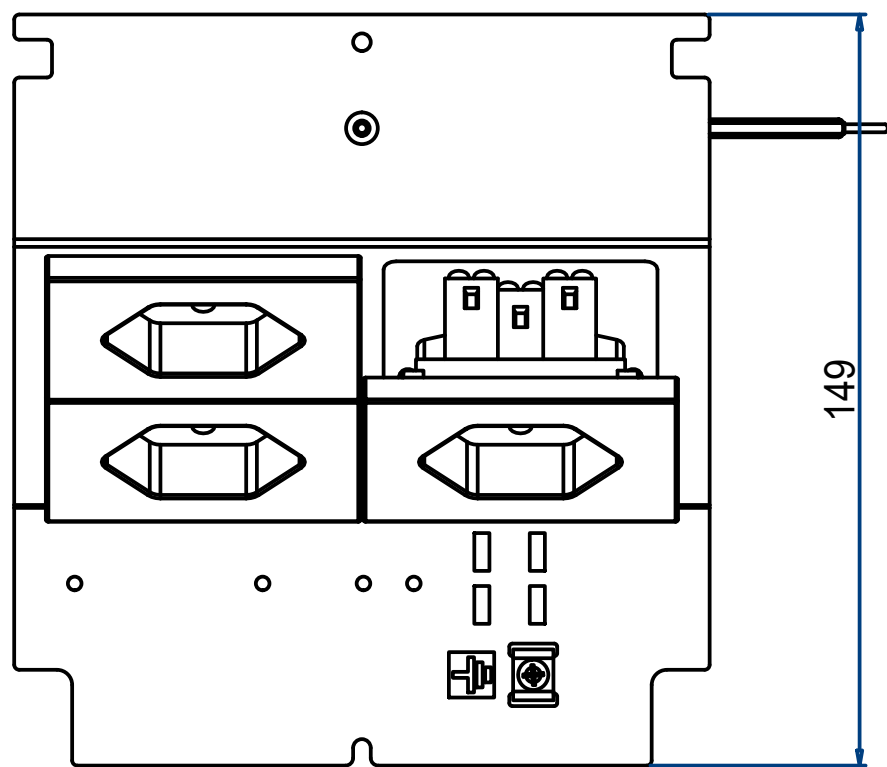
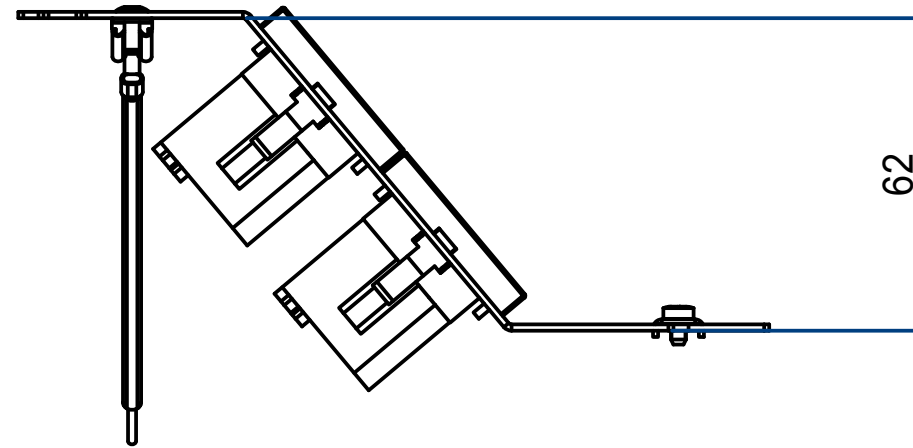
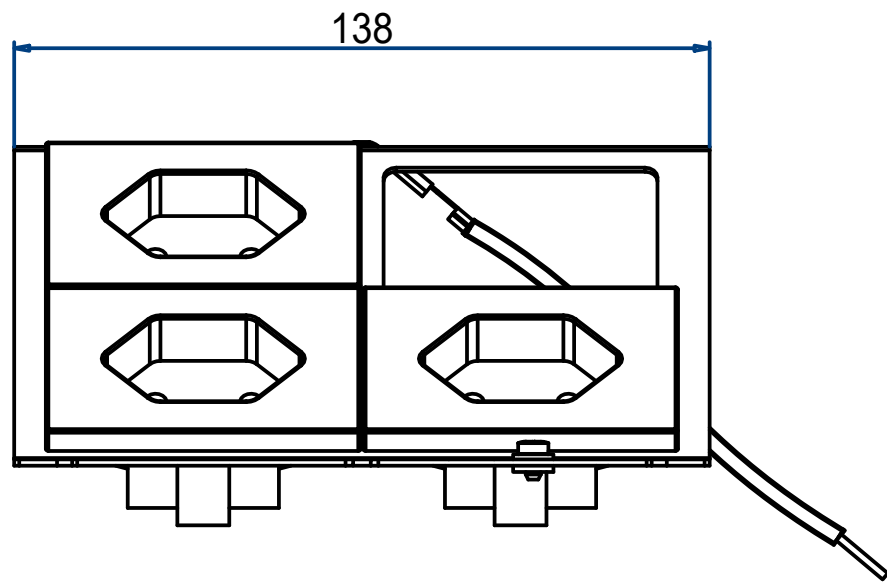

Steckdoseneinsatz für 4x FLF,  
inkl. Erddraht 2x T13 weiss  
(5520-03-312-900)

UBD 160 166

Blatt	1
Index	A3

a

# Unterflur-Bodendose UBD

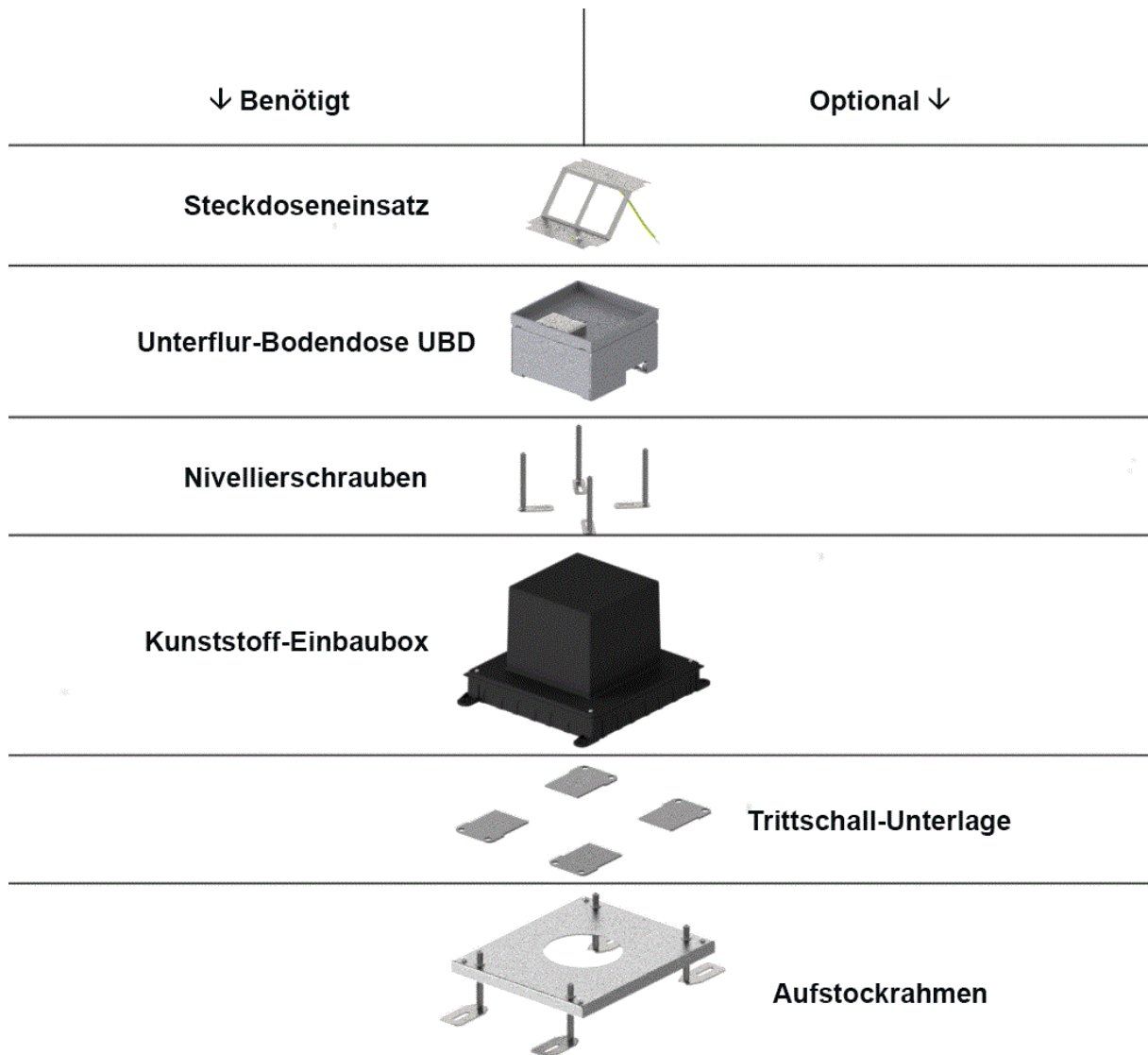

## Anmerkung

1. Etappe: Kunststoff-Einbaubox, Trittschall-Unterlage, Aufstockrahmen
2. Etappe: Unterflur-Bodendose UBD, Nivellierschrauben, Steckdoseneinsatz