

Unterflur-Bodendose UBD 160 aus Chromstahl

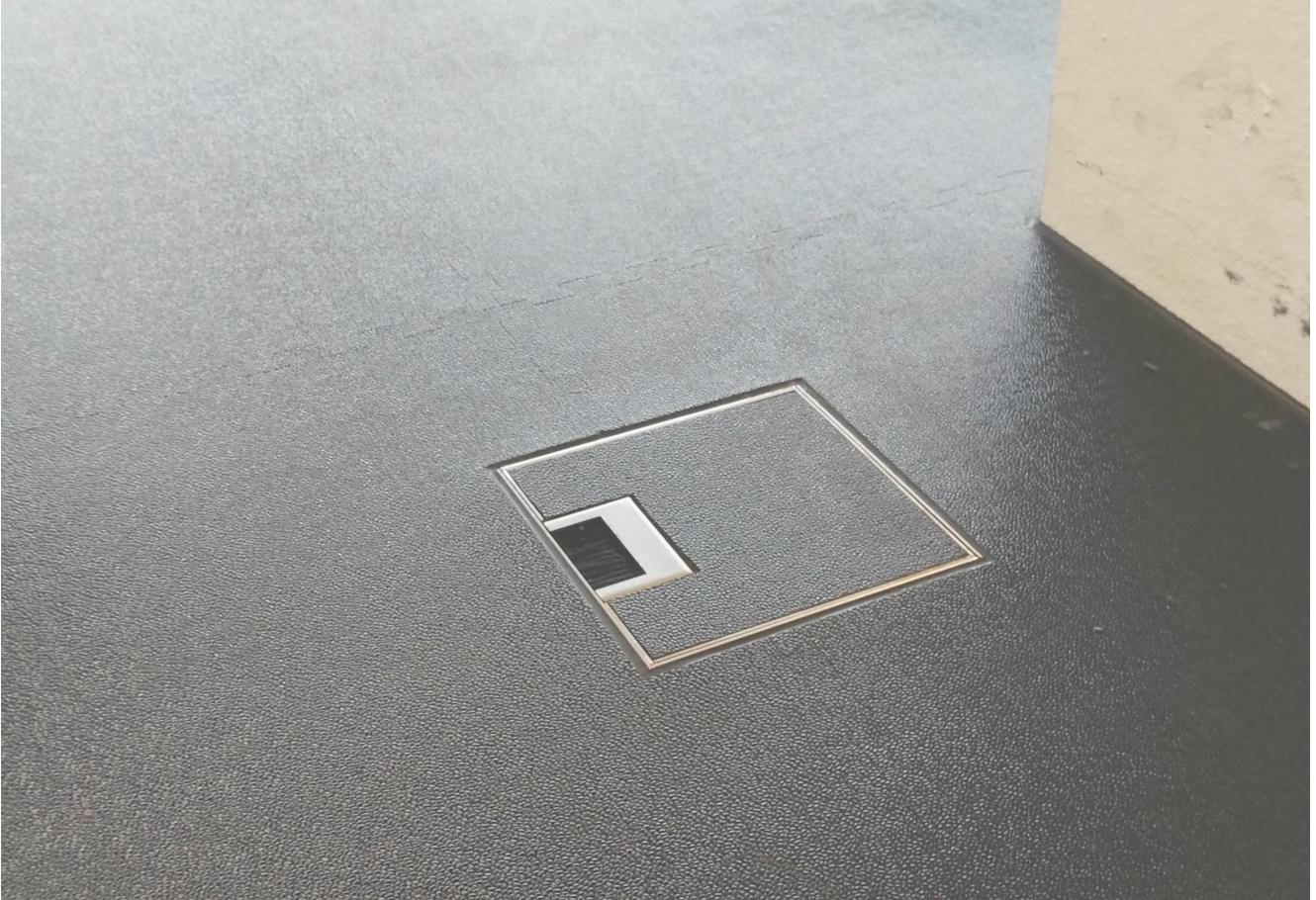

- Minimaler Bodenaufbau ab 108mm mit 5mm Vertiefung im Deckel (Isolation + Unterlagsboden + Bodenbelag)
- Mit innenliegenden Nivellierschrauben
- Rahmen, Deckel mit Kante, Auslass und Steckdoseneinsatz aus Chromstahl
- Unterteil, Deckel flach und Nivellierschrauben aus SVZ (sendzimir-verzinkter Stahl)

	Kunststoff-Einbaubox, schwarz, halogenfrei (siehe Datenblatt) oben: 170/170mm unten: 260/310mm H: 185mm
	UBD 160 198

	Trittschall-Unterlage 3mm, für Einbaubox
	Set à 4 Stk. UBD 001 002

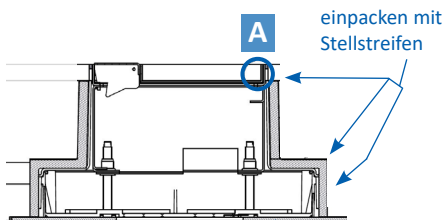
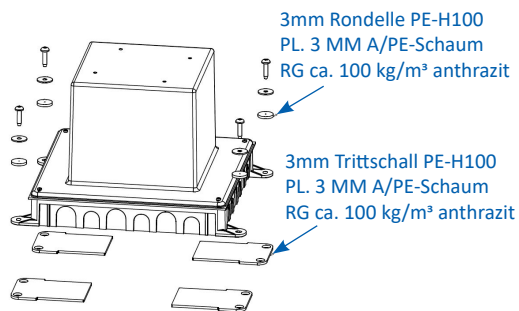

Einbaubox aufliegend WW auf 3mm Trittschall PE-H100 PL. 3 MM A/PE-Schaum, RG ca. 100 kg/m³ anthrazit

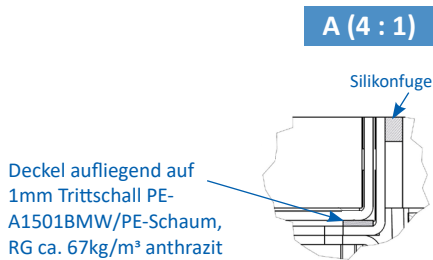

	Aufstock-Rahmen aus SVZ inkl. Nivellierschrauben zu UBD 160 und 210
	UBD 160 210 bis 90mm, mit EBB: bis 270mm
UBD 160 211	bis 165mm, mit EBB: bis 345mm

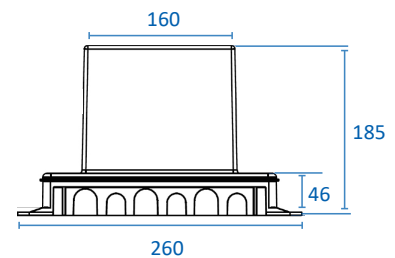

Details UBD 160 210

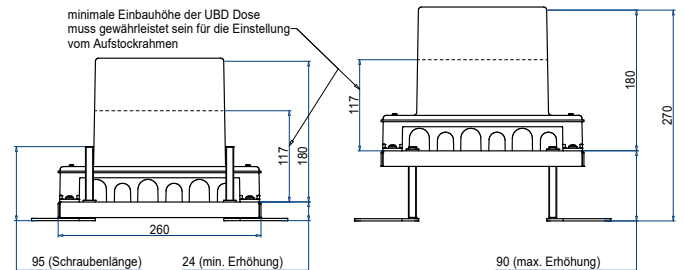

Details UBD 160 211

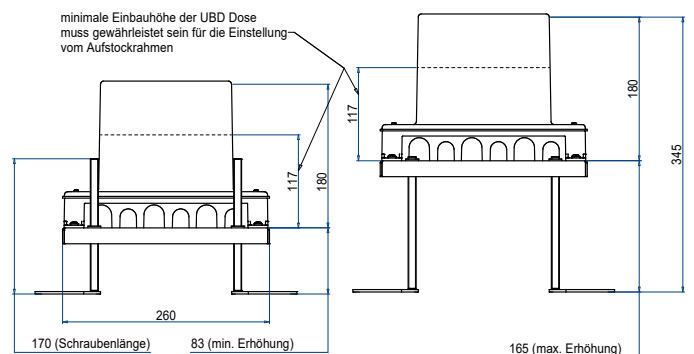

mit 15mm Vertiefung

	Unterflur-Bodendose UBD 160 aus Chromstahl inkl. Deckel mit Kante, geschlossen, 15mm Vertiefung und 1 Schnurauslass
UBD 160 155	

	Unterflur-Bodendose UBD 160 aus Chromstahl inkl. Deckel mit Kante, geschlossen, 15mm Vertiefung und 1 Bürstenauslass
UBD 160 156	

	Unterflur-Bodendose UBD 160 aus Chromstahl inkl. Blinddeckel mit Kante, geschlossen, und 15mm Vertiefung
UBD 160 159	

	Nivellierschrauben, Set à 4 Stk.
	Nivellierbereich von Roh- bis Fertigboden
UBD 001 070	116 - 161mm
UBD 001 095	128 - 186mm
UBD 001 120	153 - 211mm

Chromstahl geschliffen

	Unterflur-Bodendose UBD 160 aus Chromstahl inkl. belegtem Deckel und 1 Schnurauslass
UBD 160 157	

	Unterflur-Bodendose UBD 160 aus Chromstahl inkl. belegtem Deckel und 1 Bürstenauslass
UBD 160 158	

	Unterflur-Bodendose UBD 160 aus Chromstahl inkl. belegtem Blinddeckel
UBD 160 153	

	Nivellierschrauben, Set à 4 Stk.
	Nivellierbereich von Roh- bis Fertigboden
UBD 001 070	116 - 161mm
UBD 001 095	128 - 186mm
UBD 001 120	153 - 211mm



mit 5mm Vertiefung

	Unterflur-Bodendose UBD 160 aus Chromstahl inkl. Deckel, flach (SVZ), ohne Kante, 5mm Vertiefung und 1 Schnurauslass
UBD 162 051	

	Unterflur-Bodendose UBD 160 aus Chromstahl inkl. Deckel, flach (SVZ), ohne Kante, 5mm Vertiefung und 1 Bürstenauslass
UBD 162 052	

	Nivellierschrauben, Set à 4 Stk.
	Nivellierbereich von Roh- bis Fertigboden
UBD 001 070	108 - 153mm
UBD 001 095	120 - 178mm
UBD 001 120	145 - 203mm

mit 20mm Vertiefung

	Unterflur-Bodendose UBD 160 aus Chromstahl inkl. Deckel mit Kante, geschlossen, 20mm Vertiefung und 1 Schnurauslass
UBD 162 201	

	Unterflur-Bodendose UBD 160 aus Chromstahl inkl. Deckel mit Kante, geschlossen, 20mm Vertiefung und 1 Bürstenauslass
UBD 162 202	

	Nivellierschrauben, Set à 4 Stk.
	Nivellierbereich von Roh- bis Fertigboden
UBD 001 070	121 - 166mm
UBD 001 095	133 - 191mm
UBD 001 120	158 - 216mm

mit 25mm Vertiefung

	Unterflur-Bodendose UBD 160 aus Chromstahl inkl. Deckel mit Kante, geschlossen, 25mm Vertiefung und 1 Schnurauslass
UBD 162 251	

	Unterflur-Bodendose UBD 160 aus Chromstahl inkl. Deckel mit Kante, geschlossen, 25mm Vertiefung und 1 Bürstenauslass
UBD 162 252	

	Nivellierschrauben, Set à 4 Stk.
	Nivellierbereich von Roh- bis Fertigboden
UBD 001 070	126 - 171mm
UBD 001 095	138 - 196mm
UBD 001 120	163 - 221mm

mit 30mm Vertiefung

	Unterflur-Bodendose UBD 160 aus Chromstahl inkl. Deckel mit Kante, geschlossen, 30mm Vertiefung und 1 Schnurauslass
UBD 162 301	

	Unterflur-Bodendose UBD 160 aus Chromstahl inkl. Deckel mit Kante, geschlossen, 30mm Vertiefung und 1 Bürstenauslass
UBD 162 302	

	Nivellierschrauben, Set à 4 Stk.
	Nivellierbereich von Roh- bis Fertigboden
UBD 001 070	131 - 176mm
UBD 001 095	143 - 201mm
UBD 001 120	168 - 226mm

Schwerlast-Bodendose

	Schwerlast-Unterflur-Bodendose UBD 160 aus Chromstahl inkl. Deckel mit Kante, geschlossen, 4mm Verstärkungsplatte, 16mm Vertiefung und 1 Schnurauslass
UBD 162 161	

	Schwerlast-Unterflur-Bodendose UBD 160 aus Chromstahl inkl. Deckel mit Kante, geschlossen, 4mm Verstärkungsplatte, 16mm Vertiefung und 1 Bürstenauslass
UBD 162 162	

	Schwerlast-Unterflur-Bodendose UBD 160 aus Chromstahl inkl. belegtem Deckel, 4mm Verstärkungsplatte und 1 Bürstenauslass
UBD 162 163	

	Nivellierschrauben, Set à 4 Stk.
	Nivellierbereich von Roh- bis Fertigboden
UBD 001 070	121 - 166mm
UBD 001 095	133 - 191mm
UBD 001 120	158 - 216mm

ohne Schutzkante

	Unterflur-Bodendose UBD 160 aus Chromstahl inkl. belegtem Deckel aus 4mm SVZ, ohne Schutzkante, mit Ausschnitt
UBD 162 001	

	Nivellierschrauben, Set à 4 Stk.
	Nivellierbereich von Roh- bis Unterlagsboden
UBD 001 070	103 - 148mm
UBD 001 095	115 - 173mm
UBD 001 120	140 - 198mm

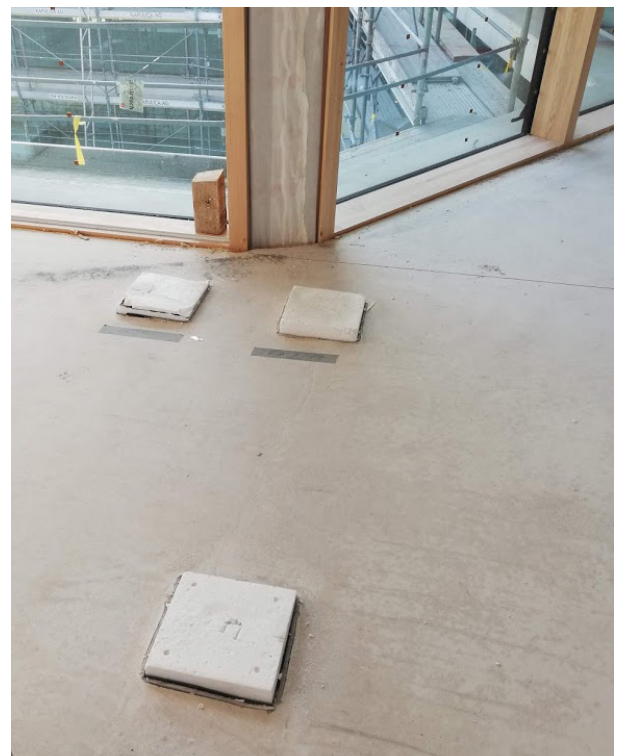

Beispiele Bestückung



1xT13 weiss + 1xT13 schwarz
+ 2xRJ45 + TV

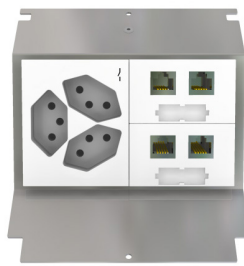

3xT13/s + 2x 2xRJ45



3xT13/s + 2xRJ45 + TV

Steckdoseneinsatz für 4 FLF

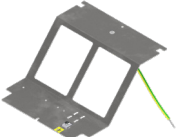
	<p>Steckdoseneinsatz für 4 FLF inkl. Erddraht, leer</p> <p>UBD 160 165</p>
---	---

Modul 45x45

	<p>Steckdoseneinsatz mit 3x 45x45- und 4x MH-Ausschnitten, leer</p> <p>UBD 160 150</p> <p>CMD 100 001, MH Blinddeckel</p> <p>CMD 100 003, MH Keystone</p>
--	--

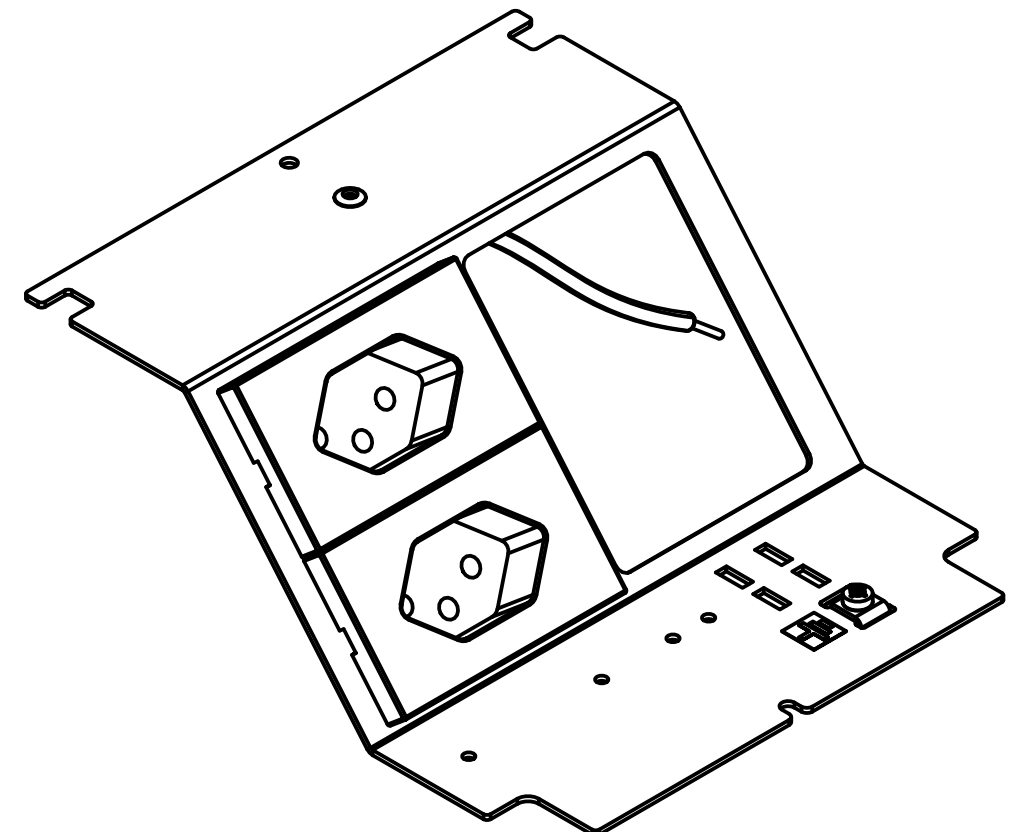
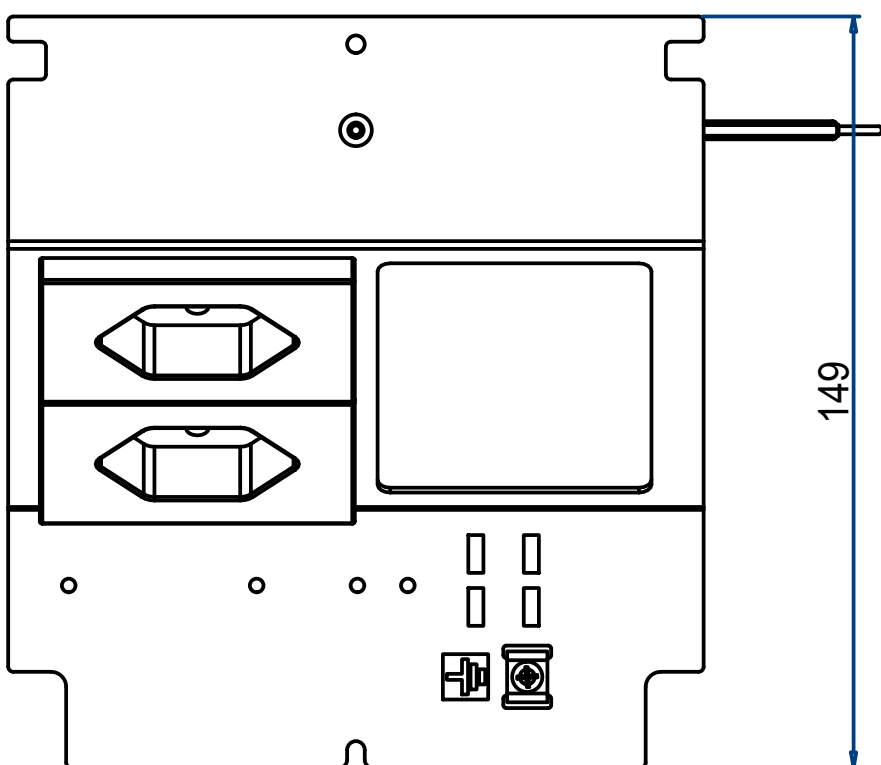
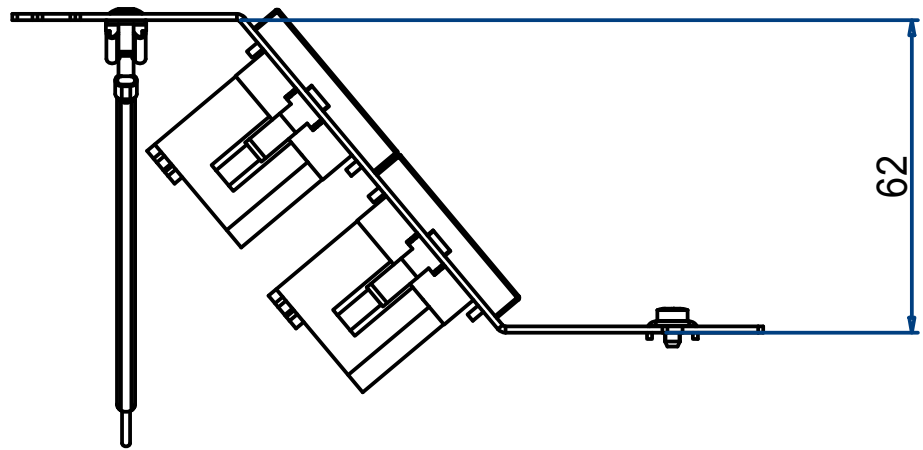
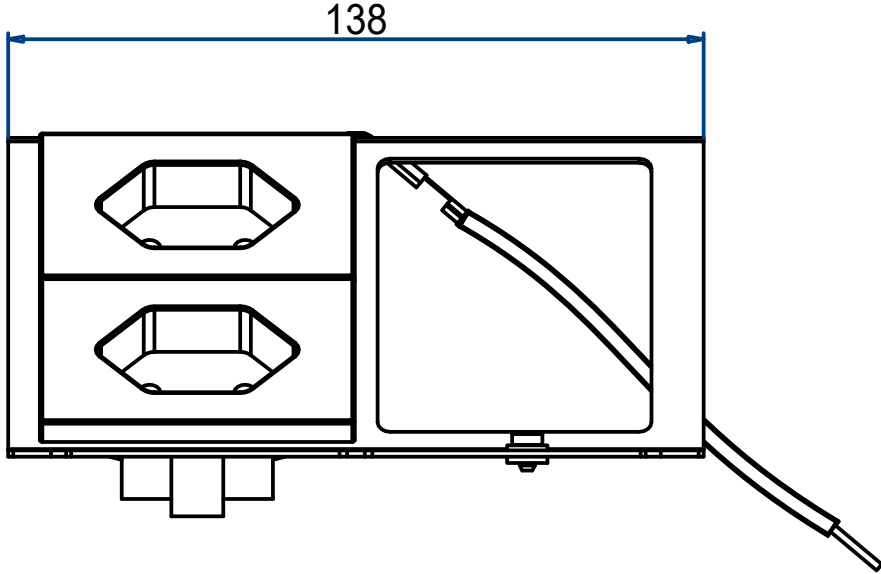
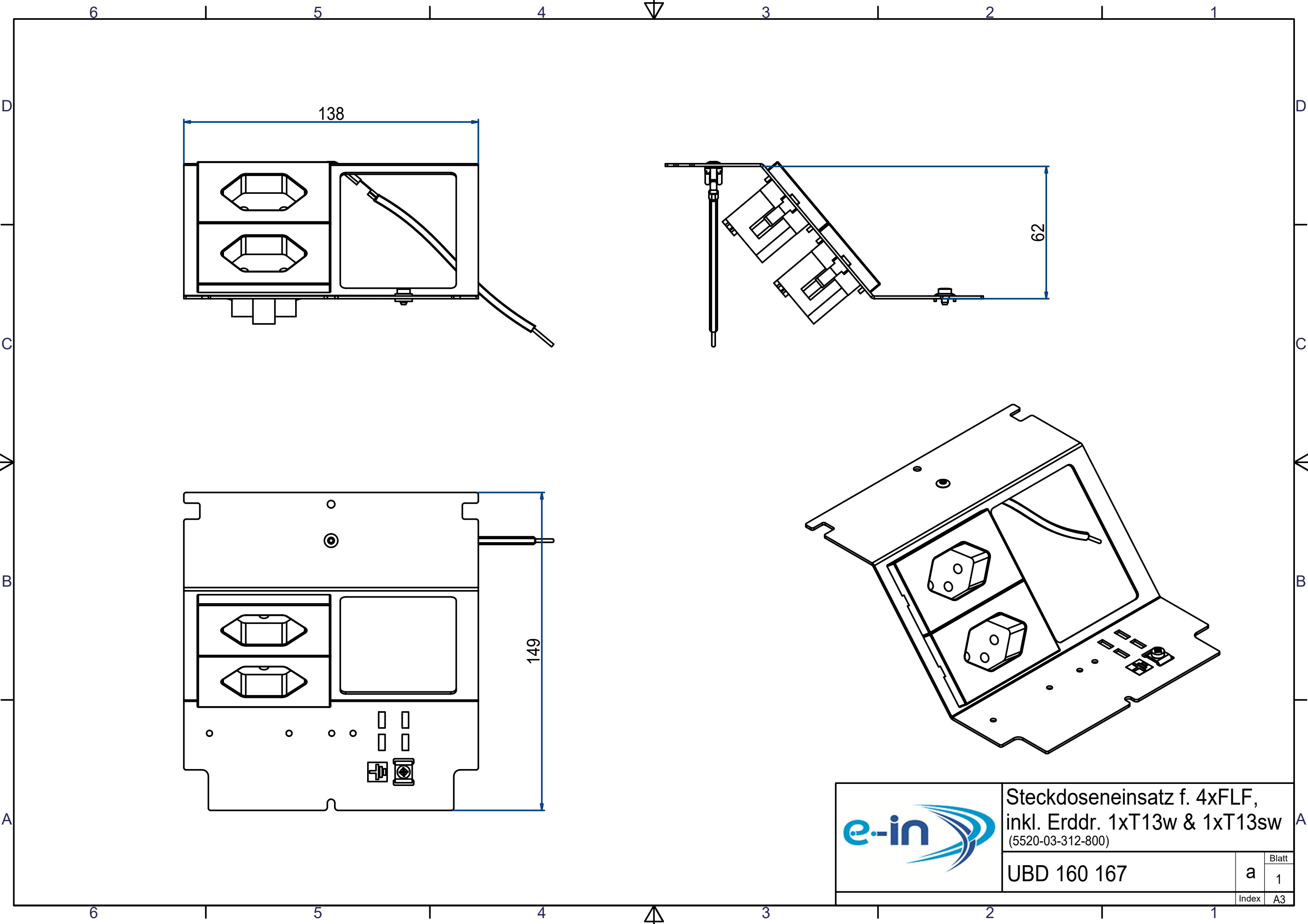

	Steckdoseneinsatz f. 4xFLF, inkl. Erddr. 1xT13w & 1xT13sw (5520-03-312-800)	
	UBD 160 167	Blatt 1
Index A3	a	1

Unterflur-Bodendose UBD

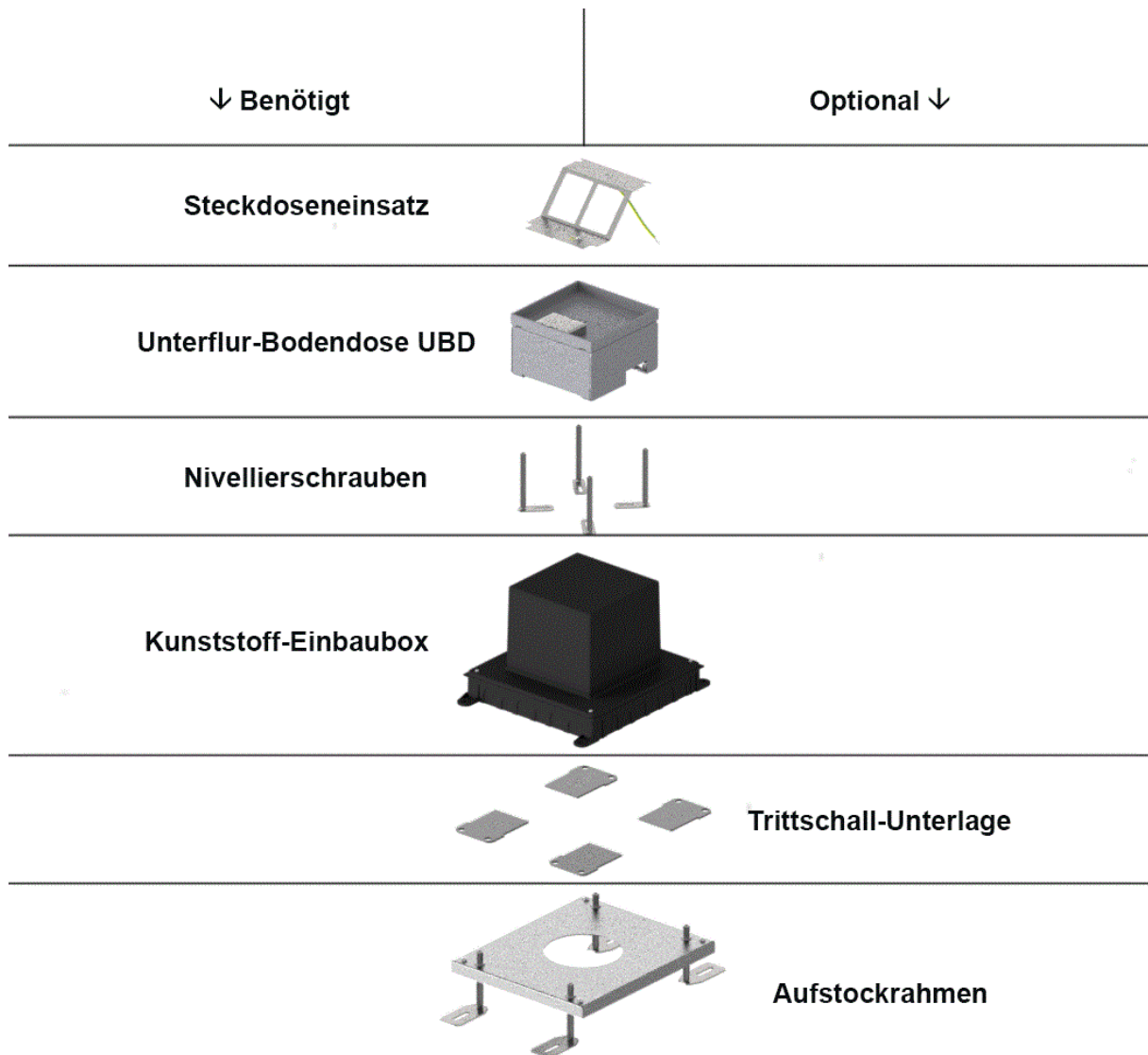

Anmerkung

1. Etappe: Kunststoff-Einbaubox, Trittschall-Unterlage, Aufstockrahmen
2. Etappe: Unterflur-Bodendose UBD, Nivellierschrauben, Steckdoseneinsatz