

Unterflur-Bodendose UBD 210 small aus Chromstahl



- Minimaler Bodenaufbau ab 70mm mit 5mm Vertiefung im Deckel (Isolation + Unterlagsboden + Bodenbelag)
- Mit innenliegenden Nivellierschrauben
- Rahmen, Deckel mit Kante, Auslass und Steckdoseneinsatz aus Chromstahl
- Unterteil, Deckel flach und Nivellierschrauben aus SVZ (sendzimir-verzinkter Stahl)





Kunststoff-Einbaubox, schwarz, halogenfrei (siehe Datenblatt)
oben: 220/220mm
unten: 260/310mm
H: 185mm

UBD 210 250



Trittschall-Unterlage 3mm, für Einbaubox

Set à 4 Stk.

UBD 001 002

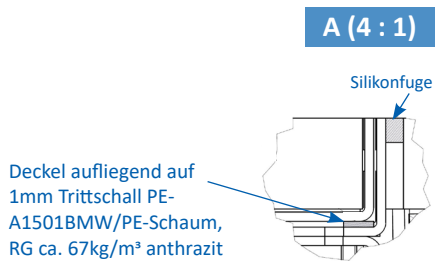
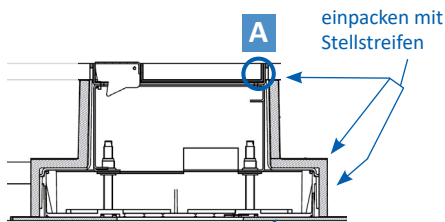
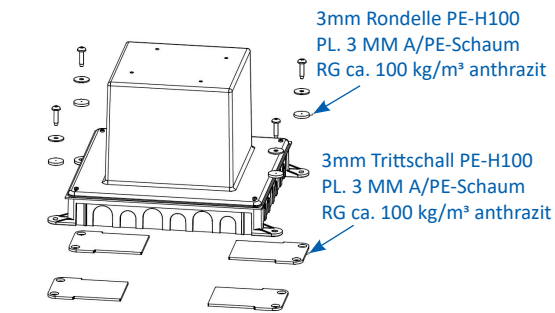

	Aufstock-Rahmen aus SVZ inkl. Nivellierschrauben zu UBD 160 und 210
UBD 160 210	bis 90mm, mit EBB: bis 270mm
UBD 160 211	bis 165mm, mit EBB: bis 345mm

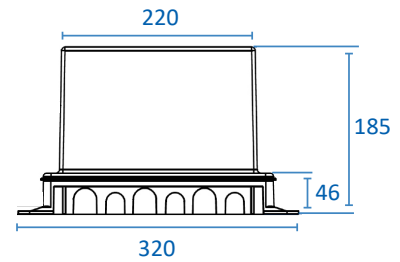

Details UBD 160 210

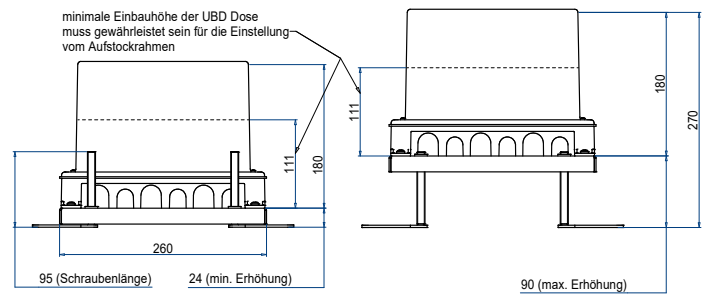

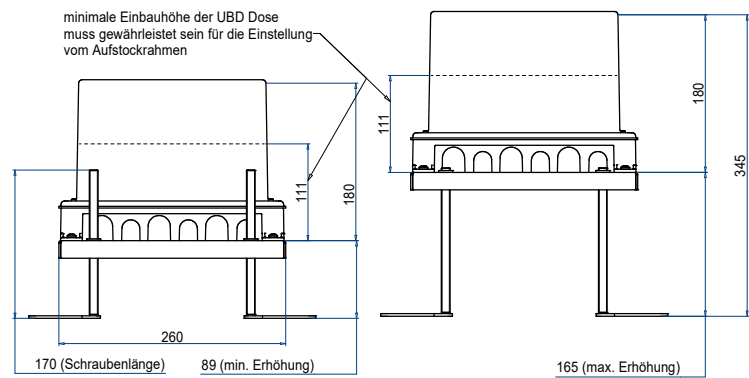

Details UBD 160 211





mit 15mm Vertiefung

	Unterflur-Bodendose UBD 210 small aus Chromstahl inkl. Deckel mit Kante, geschlossen, 15mm Vertiefung und 1 Schnur-auslass
UBD 215 205	

	Unterflur-Bodendose UBD 210 small aus Chromstahl inkl. Deckel mit Kante, 15mm Vertiefung und 2 Schnur-ausläs-sen
UBD 215 210	

	Unterflur-Bodendose UBD 210 small aus Chromstahl inkl. Deckel mit Kante, geschlossen, 15mm Vertiefung und 1 Bürstenauslass
UBD 215 206	

	Unterflur-Bodendose UBD 210 small aus Chromstahl inkl. Deckel mit Kante, 15mm Vertiefung und 2 Bürstenausläs-sen
UBD 215 211	

	Unterflur-Bodendose UBD 210 small aus Chromstahl inkl. Blind-deckel mit Kante, geschlossen, und 15mm Vertiefung
UBD 215 209	

	Nivellierschrauben, Set à 4 Stk.
	Nivellierbereich von Roh- bis Fertigboden
UBD 001 045	78 - 102mm
UBD 001 070	97 - 127mm
UBD 001 095	122 - 152mm
UBD 001 120	147 - 177mm
UBD 001 145	172 - 202mm

Chromstahl geschliffen

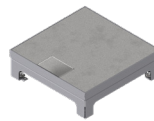
	Unterflur-Bodendose UBD 210 small aus Chromstahl inkl. belegtem Deckel und 1 Schnur-auslass
UBD 215 207	

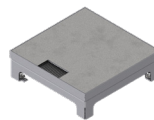
	Unterflur-Bodendose UBD 210 small aus Chromstahl inkl. belegtem Deckel und 1 Bürstenauslass
UBD 215 208	

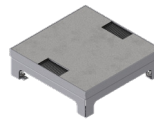
	Unterflur-Bodendose UBD 210 small aus Chromstahl inkl. belegtem Deckel und 2 Bürstenausläs-sen
UBD 215 203	

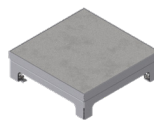
	Unterflur-Bodendose UBD 210 small aus Chromstahl inkl. belegtem Blinddeckel
UBD 215 202	

	Nivellierschrauben, Set à 4 Stk.
	Nivellierbereich von Roh- bis Fertigboden
UBD 001 045	78 - 102mm
UBD 001 070	97 - 127mm
UBD 001 095	122 - 152mm
UBD 001 120	147 - 177mm
UBD 001 145	172 - 202mm



mit 5mm Vertiefung

	Unterflur-Bodendose UBD 210 small aus Chromstahl inkl. Deckel, flach (SVZ), ohne Kante, 5mm Vertiefung und 1 Schnur auslass
UBD 217 051	

	Unterflur-Bodendose UBD 210 small aus Chromstahl inkl. Deckel, flach (SVZ), 5mm Vertiefung und 1 Bürstenauslass
UBD 217 052	

	Nivellierschrauben, Set à 4 Stk. Nivellierbereich von Roh- bis Fertigboden
UBD 001 045	70 - 94mm
UBD 001 070	89 - 119mm
UBD 001 095	114 - 144mm

mit 20mm Vertiefung

	Unterflur-Bodendose UBD 210 small aus Chromstahl inkl. Deckel mit Kante, geschlossen, 20mm Vertiefung und 1 Schnur auslass
UBD 217 201	

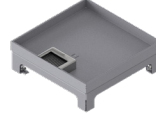
	Unterflur-Bodendose UBD 210 small aus Chromstahl inkl. Deckel mit Kante, geschlossen, 20mm Vertiefung und 1 Bürstenauslass
UBD 217 202	

	Nivellierschrauben, Set à 4 Stk. Nivellierbereich von Roh- bis Fertigboden
UBD 001 045	83 - 107mm
UBD 001 070	102 - 132mm
UBD 001 095	127 - 157mm

mit 25mm Vertiefung

	Unterflur-Bodendose UBD 210 small aus Chromstahl inkl. Deckel mit Kante, geschlossen, 25mm Vertiefung und 1 Schnur auslass
UBD 217 251	

	Unterflur-Bodendose UBD 210 small aus Chromstahl inkl. Deckel mit Kante, geschlossen, 25mm Vertiefung und 1 Bürstenauslass
UBD 217 252	

	Nivellierschrauben, Set à 4 Stk. Nivellierbereich von Roh- bis Fertigboden
UBD 001 045	88 - 112mm
UBD 001 070	107 - 137mm
UBD 001 095	132 - 162mm

mit 30mm Vertiefung

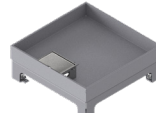
	Unterflur-Bodendose UBD 210 small aus Chromstahl inkl. Deckel mit Kante, geschlossen, 30mm Vertiefung und 1 Schnur auslass
UBD 217 301	

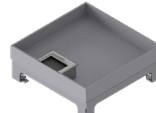
	Unterflur-Bodendose UBD 210 small aus Chromstahl inkl. Deckel mit Kante, geschlossen, 30mm Vertiefung und 1 Bürstenauslass
UBD 217 302	

	Nivellierschrauben, Set à 4 Stk. Nivellierbereich von Roh- bis Fertigboden
UBD 001 045	93 - 117mm
UBD 001 070	112 - 142mm
UBD 001 095	137 - 167mm

Schwerlast-Bodendose

	Schwerlast-Unterflur-Bodendose UBD 210 small aus Chromstahl inkl. Deckel mit Kante, geschlossen, 4mm Verstärkungsplatte, 16mm Vertiefung und 1 Schnurauslass
UBD 217 161	

	Schwerlast-Unterflur-Bodendose UBD 210 small aus Chromstahl inkl. Deckel mit Kante, geschlossen, 4mm Verstärkungsplatte, 16mm Vertiefung und 1 Bürstenauslass
UBD 217 162	

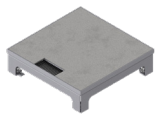
	Schwerlast-Unterflur-Bodendose UBD 210 small aus Chromstahl inkl. belegtem Deckel mit 4mm Verstärkungsplatte und 1 Bürstenauslass
UBD 217 163	

ohne Schutzkante

	Unterflur-Bodendose UBD 210 small aus Chromstahl inkl. belegtem Deckel aus 4mm SVZ, ohne Schutzkante, mit Ausschnitt
UBD 217 001	

	Nivellierschrauben, Set à 4 Stk.
	Nivellierbereich von Roh- bis Unterlagsboden
UBD 001 045	65 - 89mm
UBD 001 070	84 - 114mm
UBD 001 095	109 - 139mm

	Nivellierschrauben, Set à 4 Stk.
	Nivellierbereich von Roh- bis Fertigboden
UBD 001 045	83 - 107mm
UBD 001 070	102 - 132mm
UBD 001 095	127 - 157mm



Steckdoseneinsatz für 5 FLF (3+2) ab 70mm, mit 5mm Vertiefung im Deckel

horizontal

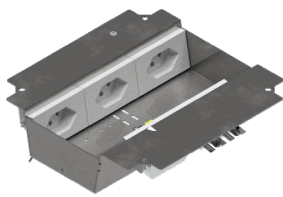
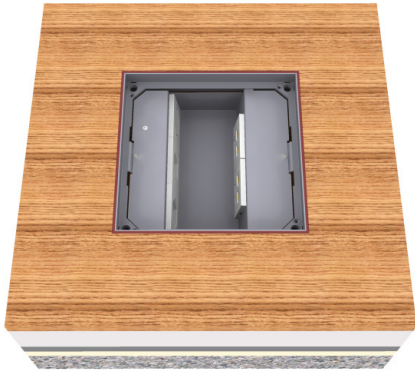

3x 1xT13 weiss

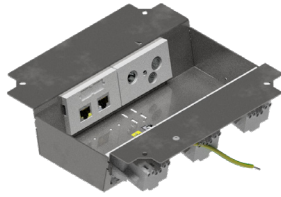

2x 2xRJ45 + TV

Steckdoseneinsatz für 8 FLF (2x4) ab 89mm, mit 5mm Vertiefung im Deckel

vertikal

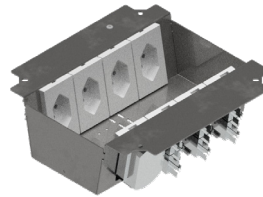

4x 1xT13 weiss

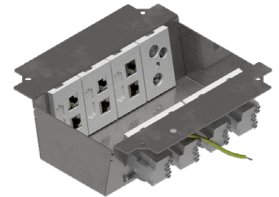

3x 2xRJ45 + TV



Steckdoseneinsatz für 3+2 FLF
inkl. Erddraht, leer

UBD 215 225



Steckdoseneinsatz mit 2x 3x
45x45-Ausschnitten, leer

UBD 215 245

Modul 45x45



Steckdoseneinsatz für 2x3Stk.
45x45 Ausschnitte, leer

UBD 215 240

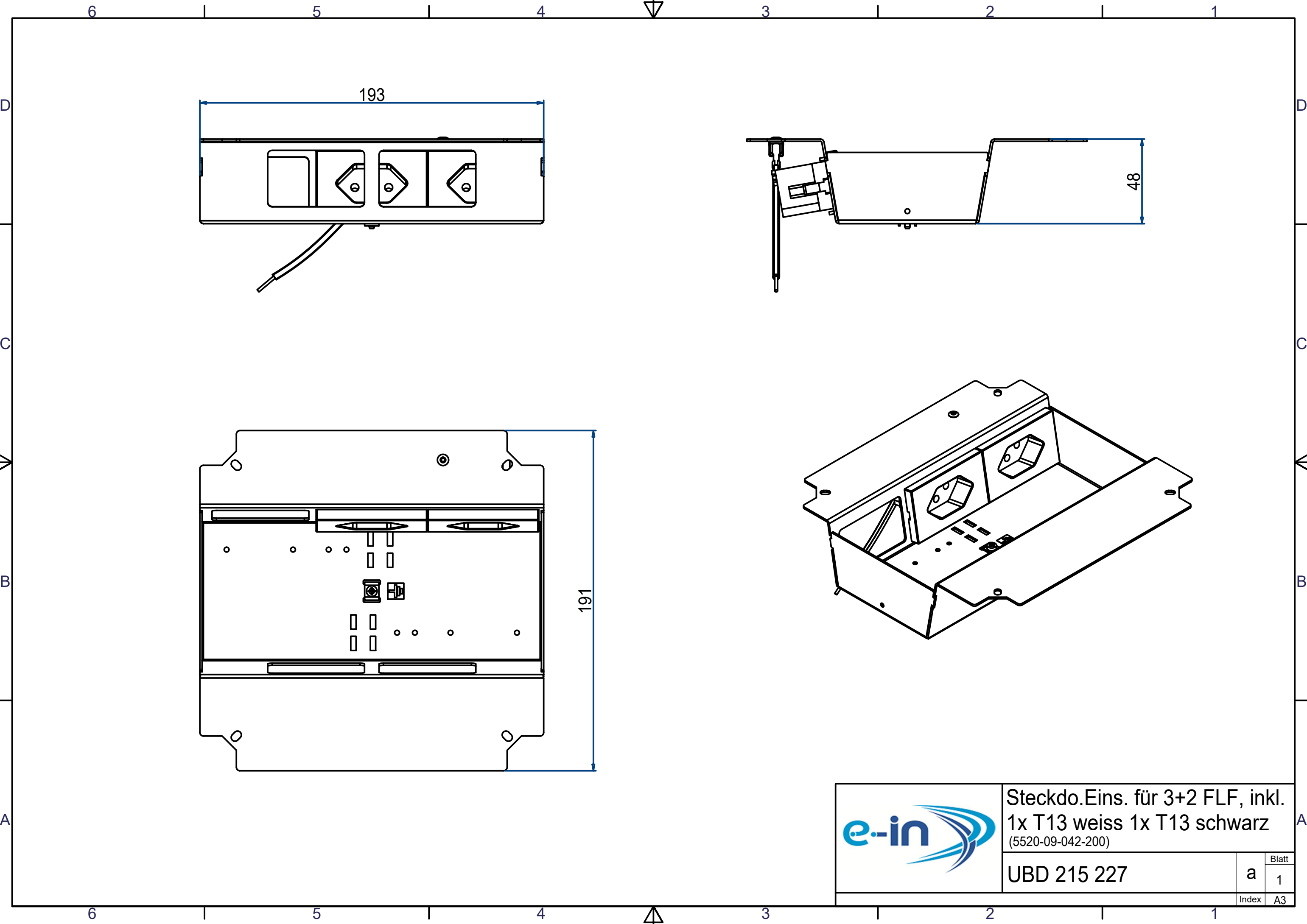

Steckdo.Eins. für 3+2 FLF, inkl.
 1x T13 weiss 1x T13 schwarz
 (5520-09-042-200)

UBD 215 227

Blatt	1
Index	A3

a

Unterflur-Bodendose UBD

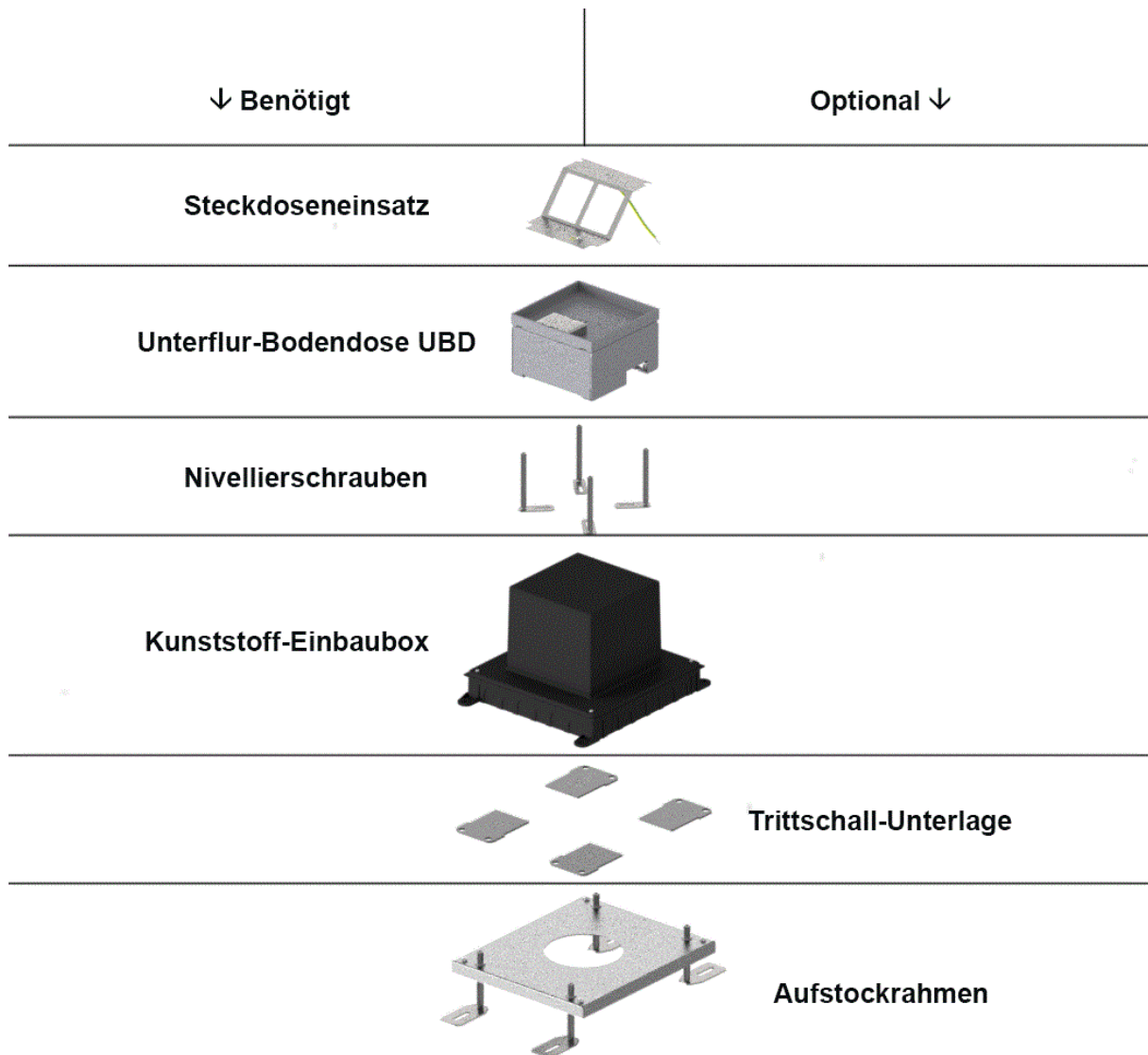

Anmerkung

1. Etappe: Kunststoff-Einbaubox, Trittschall-Unterlage, Aufstockrahmen
2. Etappe: Unterflur-Bodendose UBD, Nivellierschrauben, Steckdoseneinsatz