

## Unterflur-Bodendose UBD 210 small aus Chromstahl

---



- Minimaler Bodenaufbau ab 70mm mit 5mm Vertiefung im Deckel (Isolation + Unterlagsboden + Bodenbelag)
- Mit innenliegenden Nivellierschrauben
- Rahmen, Deckel mit Kante, Auslass und Steckdoseneinsatz aus Chromstahl
- Unterteil, Deckel flach und Nivellierschrauben aus SVZ (sendzimir-verzinkter Stahl)





Kunststoff-Einbaubox, schwarz, halogenfrei (siehe Datenblatt)  
oben: 220/220mm  
unten: 260/310mm  
H: 185mm

**UBD 210 250**



Trittschall-Unterlage 3mm, für Einbaubox

Set à 4 Stk.

**UBD 001 002**

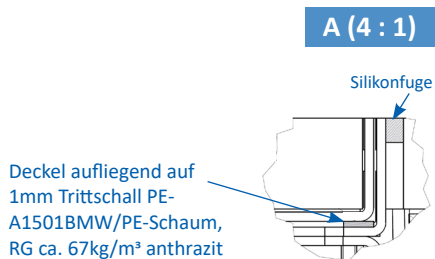
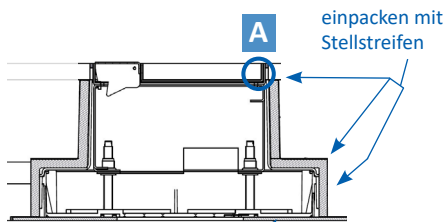
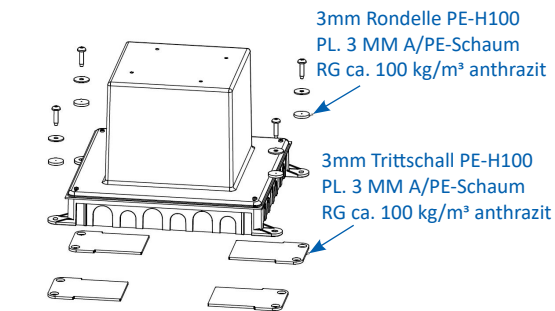



Aufstock-Rahmen aus SVZ inkl. Nivellierschrauben zu UBD 160 und 210

**UBD 160 210** bis 90mm, mit EBB: bis 270mm

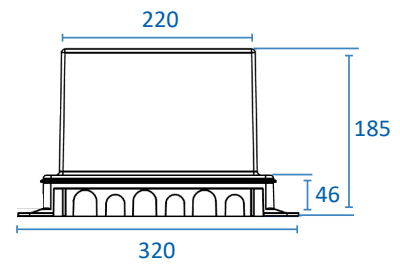
**UBD 160 211** bis 165mm, mit EBB: bis 345mm

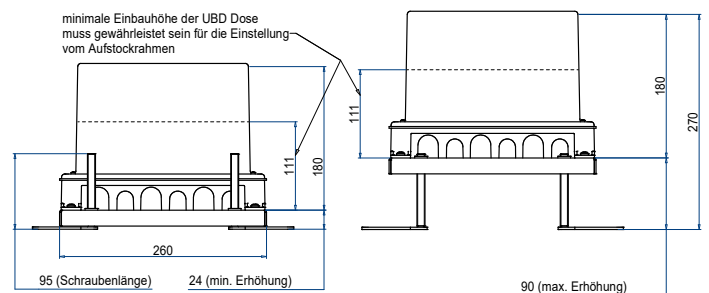

**Details UBD 160 210**



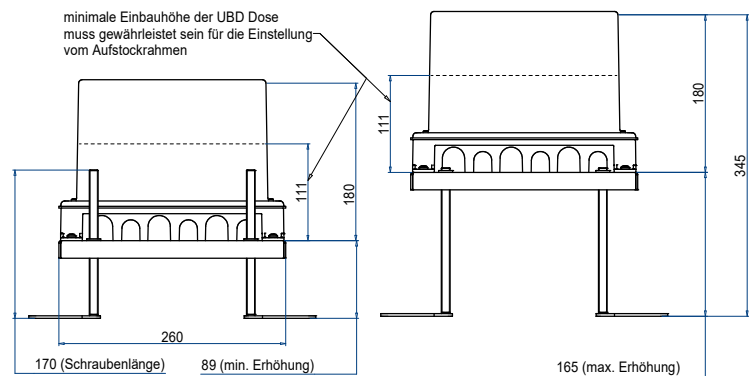

**Details UBD 160 211**





## mit 15mm Vertiefung

	Unterflur-Bodendose UBD 210 small aus Chromstahl inkl. Deckel mit Kante, geschlossen, 15mm Vertiefung und 1 Schnur­auslass
<b>UBD 215 205</b>	

	Unterflur-Bodendose UBD 210 small aus Chromstahl inkl. Deckel mit Kante, 15mm Vertiefung und 2 Schnur­ausläs­sen
<b>UBD 215 210</b>	

	Unterflur-Bodendose UBD 210 small aus Chromstahl inkl. Deckel mit Kante, geschlossen, 15mm Vertiefung und 1 Bürstenauslass
<b>UBD 215 206</b>	

	Unterflur-Bodendose UBD 210 small aus Chromstahl inkl. Deckel mit Kante, 15mm Vertiefung und 2 Bürstenausläs­sen
<b>UBD 215 211</b>	

	Unterflur-Bodendose UBD 210 small aus Chromstahl inkl. Blind­deckel mit Kante, geschlossen, und 15mm Vertiefung
<b>UBD 215 209</b>	

	Nivellierschrauben, Set à 4 Stk.  Nivellierbereich von Roh- bis Fertigboden
<b>UBD 001 045</b>	78 - 102mm
<b>UBD 001 070</b>	97 - 127mm
<b>UBD 001 095</b>	122 - 152mm
<b>UBD 001 120</b>	147 - 177mm
<b>UBD 001 145</b>	172 - 202mm

## Chromstahl geschliffen

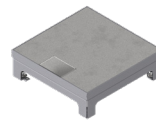
	Unterflur-Bodendose UBD 210 small aus Chromstahl inkl. belegtem Deckel und 1 Schnur­auslass
<b>UBD 215 207</b>	

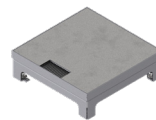
	Unterflur-Bodendose UBD 210 small aus Chromstahl inkl. belegtem Deckel und 1 Bürstenauslass
<b>UBD 215 208</b>	

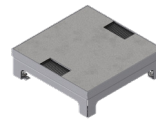
	Unterflur-Bodendose UBD 210 small aus Chromstahl inkl. belegtem Deckel und 2 Bürstenausläs­sen
<b>UBD 215 203</b>	

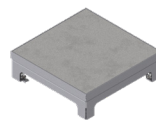
	Unterflur-Bodendose UBD 210 small aus Chromstahl inkl. belegtem Blinddeckel
<b>UBD 215 202</b>	

	Nivellierschrauben, Set à 4 Stk.  Nivellierbereich von Roh- bis Fertigboden
<b>UBD 001 045</b>	78 - 102mm
<b>UBD 001 070</b>	97 - 127mm
<b>UBD 001 095</b>	122 - 152mm
<b>UBD 001 120</b>	147 - 177mm
<b>UBD 001 145</b>	172 - 202mm







## mit 5mm Vertiefung

	Unterflur-Bodendose UBD 210 small aus Chromstahl inkl. Deckel, flach (SVZ), ohne Kante, 5mm Vertiefung und 1 Schnuraustritt
<b>UBD 217 051</b>	

	Unterflur-Bodendose UBD 210 small aus Chromstahl inkl. Deckel, flach (SVZ), 5mm Vertiefung und 1 Bürstenauslass
<b>UBD 217 052</b>	

	Nivellierschrauben, Set à 4 Stk.  Nivellierbereich von Roh- bis Fertigboden
<b>UBD 001 045</b>	70 - 94mm
<b>UBD 001 070</b>	89 - 119mm
<b>UBD 001 095</b>	114 - 144mm

## mit 20mm Vertiefung

	Unterflur-Bodendose UBD 210 small aus Chromstahl inkl. Deckel mit Kante, geschlossen, 20mm Vertiefung und 1 Schnuraustritt
<b>UBD 217 201</b>	

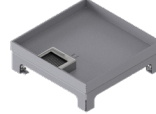
	Unterflur-Bodendose UBD 210 small aus Chromstahl inkl. Deckel mit Kante, geschlossen, 20mm Vertiefung und 1 Bürstenauslass
<b>UBD 217 202</b>	

	Nivellierschrauben, Set à 4 Stk.  Nivellierbereich von Roh- bis Fertigboden
<b>UBD 001 045</b>	83 - 107mm
<b>UBD 001 070</b>	102 - 132mm
<b>UBD 001 095</b>	127 - 157mm

## mit 25mm Vertiefung

	Unterflur-Bodendose UBD 210 small aus Chromstahl inkl. Deckel mit Kante, geschlossen, 25mm Vertiefung und 1 Schnuraustritt
<b>UBD 217 251</b>	

	Unterflur-Bodendose UBD 210 small aus Chromstahl inkl. Deckel mit Kante, geschlossen, 25mm Vertiefung und 1 Bürstenauslass
<b>UBD 217 252</b>	

	Nivellierschrauben, Set à 4 Stk.  Nivellierbereich von Roh- bis Fertigboden
<b>UBD 001 045</b>	88 - 112mm
<b>UBD 001 070</b>	107 - 137mm
<b>UBD 001 095</b>	132 - 162mm

## mit 30mm Vertiefung

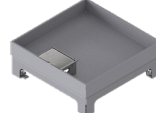
	Unterflur-Bodendose UBD 210 small aus Chromstahl inkl. Deckel mit Kante, geschlossen, 30mm Vertiefung und 1 Schnuraustritt
<b>UBD 217 301</b>	

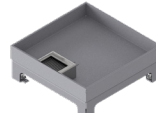
	Unterflur-Bodendose UBD 210 small aus Chromstahl inkl. Deckel mit Kante, geschlossen, 30mm Vertiefung und 1 Bürstenauslass
<b>UBD 217 302</b>	

	Nivellierschrauben, Set à 4 Stk.  Nivellierbereich von Roh- bis Fertigboden
<b>UBD 001 045</b>	93 - 117mm
<b>UBD 001 070</b>	112 - 142mm
<b>UBD 001 095</b>	137 - 167mm

## Schwerlast-Bodendose

	Schwerlast-Unterflur-Bodendose UBD 210 small aus Chromstahl inkl. Deckel mit Kante, geschlossen, 4mm Verstärkungsplatte, 16mm Vertiefung und 1 Schnuraustritt
<b>UBD 217 161</b>	

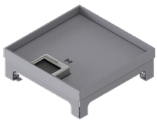
	Schwerlast-Unterflur-Bodendose UBD 210 small aus Chromstahl inkl. Deckel mit Kante, geschlossen, 4mm Verstärkungsplatte, 16mm Vertiefung und 1 Bürstenauslass
<b>UBD 217 162</b>	

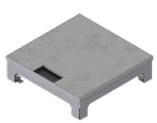
	Schwerlast-Unterflur-Bodendose UBD 210 small aus Chromstahl inkl. belegtem Deckel mit 4mm Verstärkungsplatte und 1 Bürstenauslass
<b>UBD 217 163</b>	

## ohne Schutzkante

	Unterflur-Bodendose UBD 210 small aus Chromstahl inkl. belegtem Deckel aus 4mm SVZ, ohne Schutzkante, mit Ausschnitt
<b>UBD 217 001</b>	

	Nivellierschrauben, Set à 4 Stk.
	Nivellierbereich von Roh- bis Unterlagsboden
<b>UBD 001 045</b>	65 - 89mm
<b>UBD 001 070</b>	84 - 114mm
<b>UBD 001 095</b>	109 - 139mm

	Nivellierschrauben, Set à 4 Stk.
	Nivellierbereich von Roh- bis Fertigboden
<b>UBD 001 045</b>	83 - 107mm
<b>UBD 001 070</b>	102 - 132mm
<b>UBD 001 095</b>	127 - 157mm



## Steckdoseneinsatz für 5 FLF (3+2) ab 70mm, mit 5mm Vertiefung im Deckel

horizontal

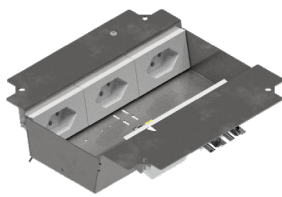
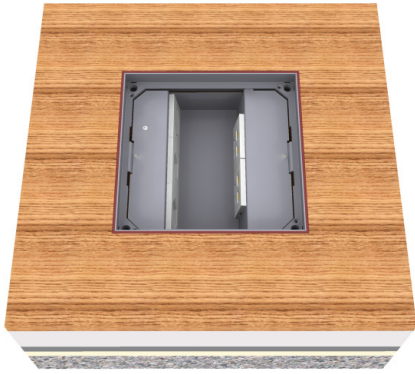

3x 1xT13 weiss

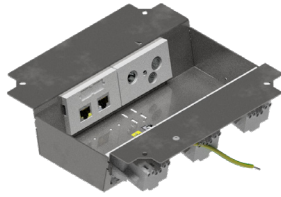

2x 2xRJ45 + TV

## Steckdoseneinsatz für 8 FLF (2x4) ab 89mm, mit 5mm Vertiefung im Deckel

vertikal

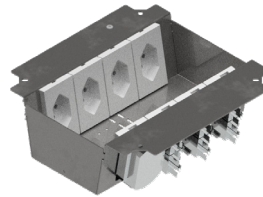

4x 1xT13 weiss

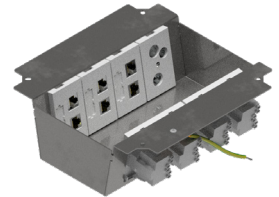

3x 2xRJ45 + TV

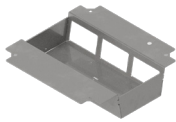

Steckdoseneinsatz für 3+2 FLF  
inkl. Erddraht, leer

UBD 215 225

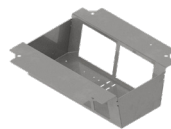

Steckdoseneinsatz mit 2x 3x  
45x45-Ausschnitten, leer

UBD 215 245

## Modul 45x45



Steckdoseneinsatz für 2x3Stk.  
45x45 Ausschnitte, leer

UBD 215 240

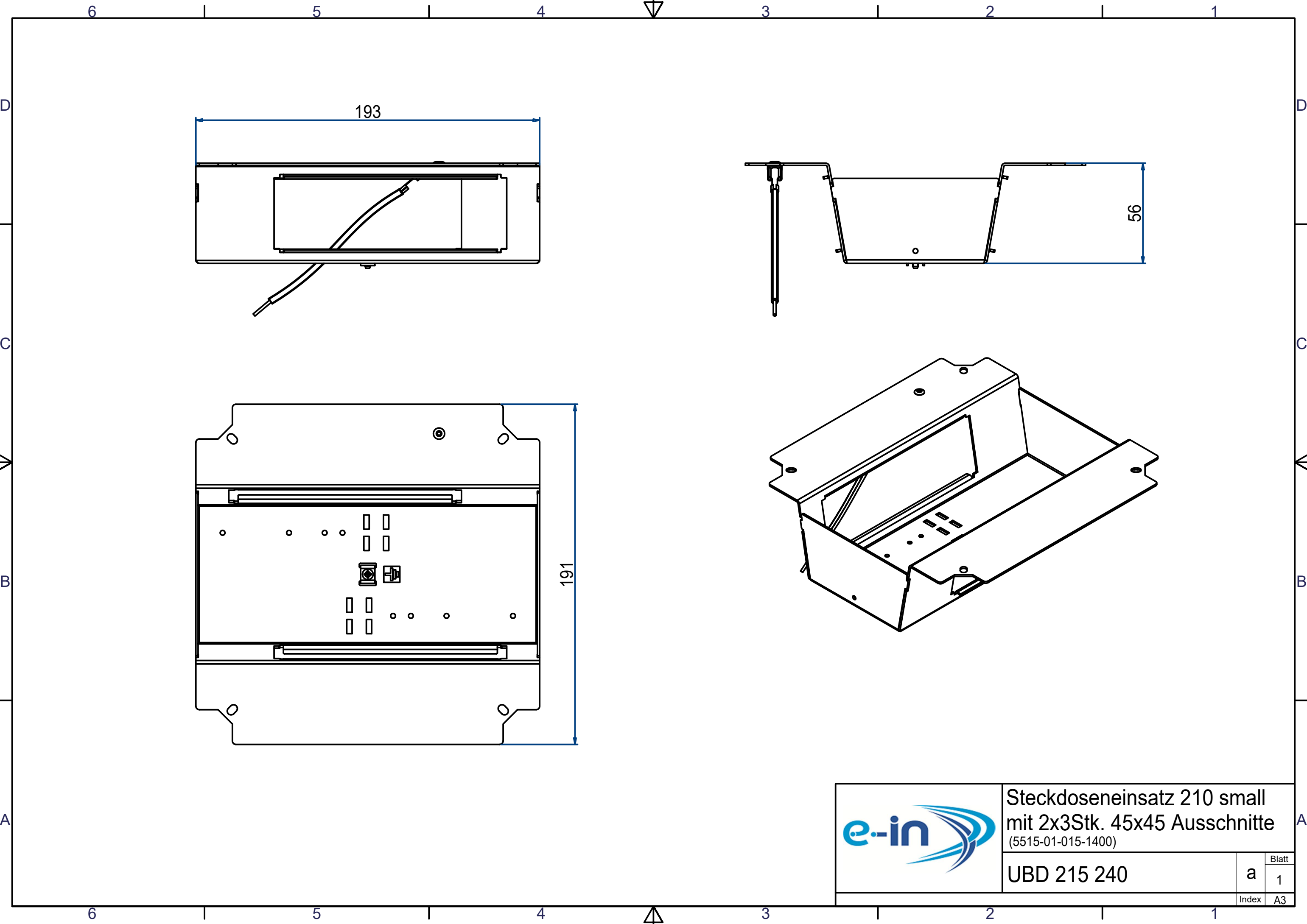



193

56

191

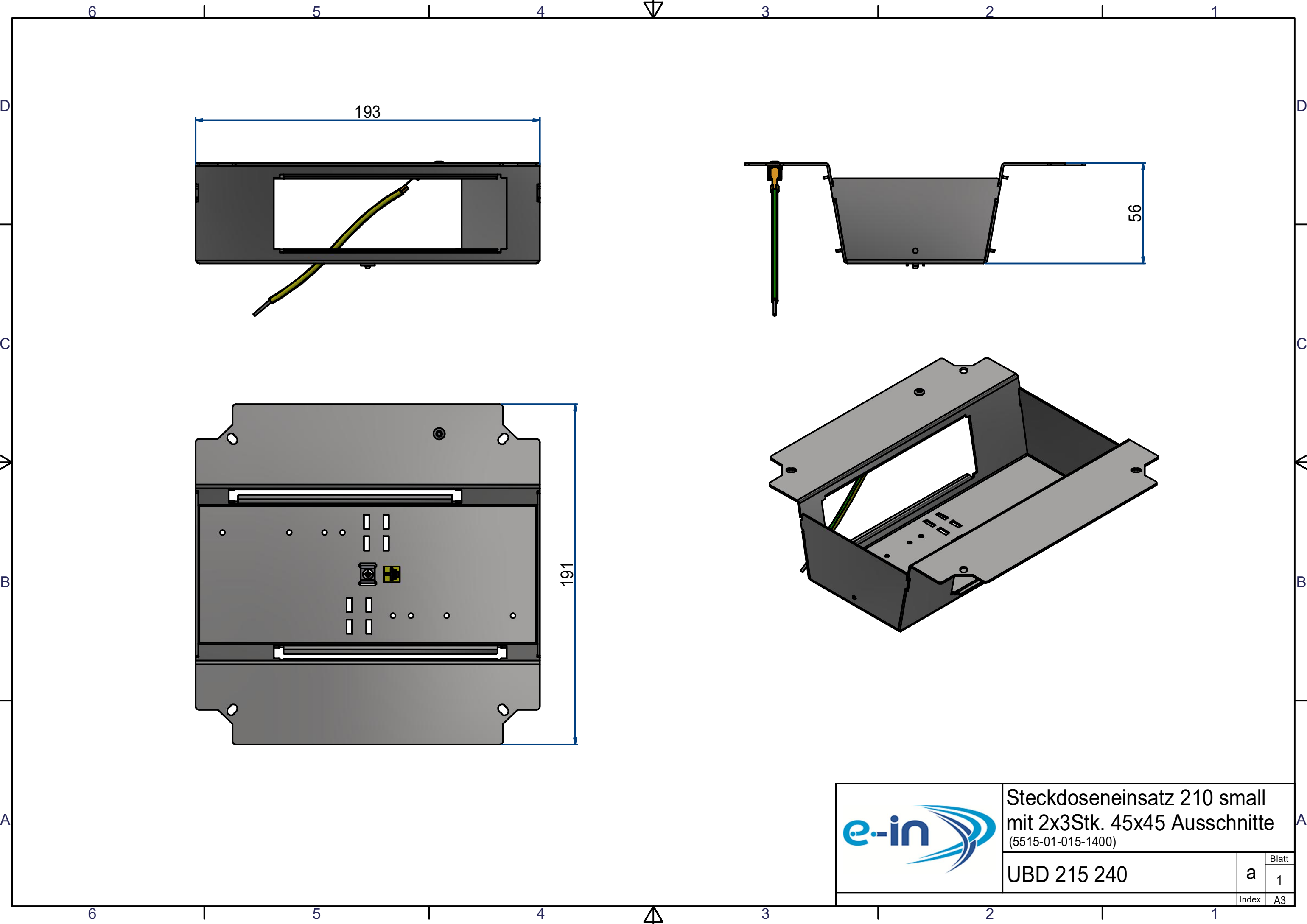
	<b>Steckdoseneinsatz 210 small</b> mit 2x3Stk. 45x45 Ausschnitte (5515-01-015-1400)	
	<b>UBD 215 240</b>	Blatt <b>1</b>
Index <b>A3</b>		



	<b>Steckdoseneinsatz 210 small</b> mit 2x3Stk. 45x45 Ausschnitte (5515-01-015-1400)	
	<b>UBD 215 240</b>	Blatt 1
Index A3		



# Unterflur-Bodendose UBD



## Anmerkung

1. Etappe: Kunststoff-Einbaubox, Trittschall-Unterlage, Aufstockrahmen
2. Etappe: Unterflur-Bodendose UBD, Nivellierschrauben, Steckdoseneinsatz