

## Unterflur-Bodendose UBD 260 aus Chromstahl

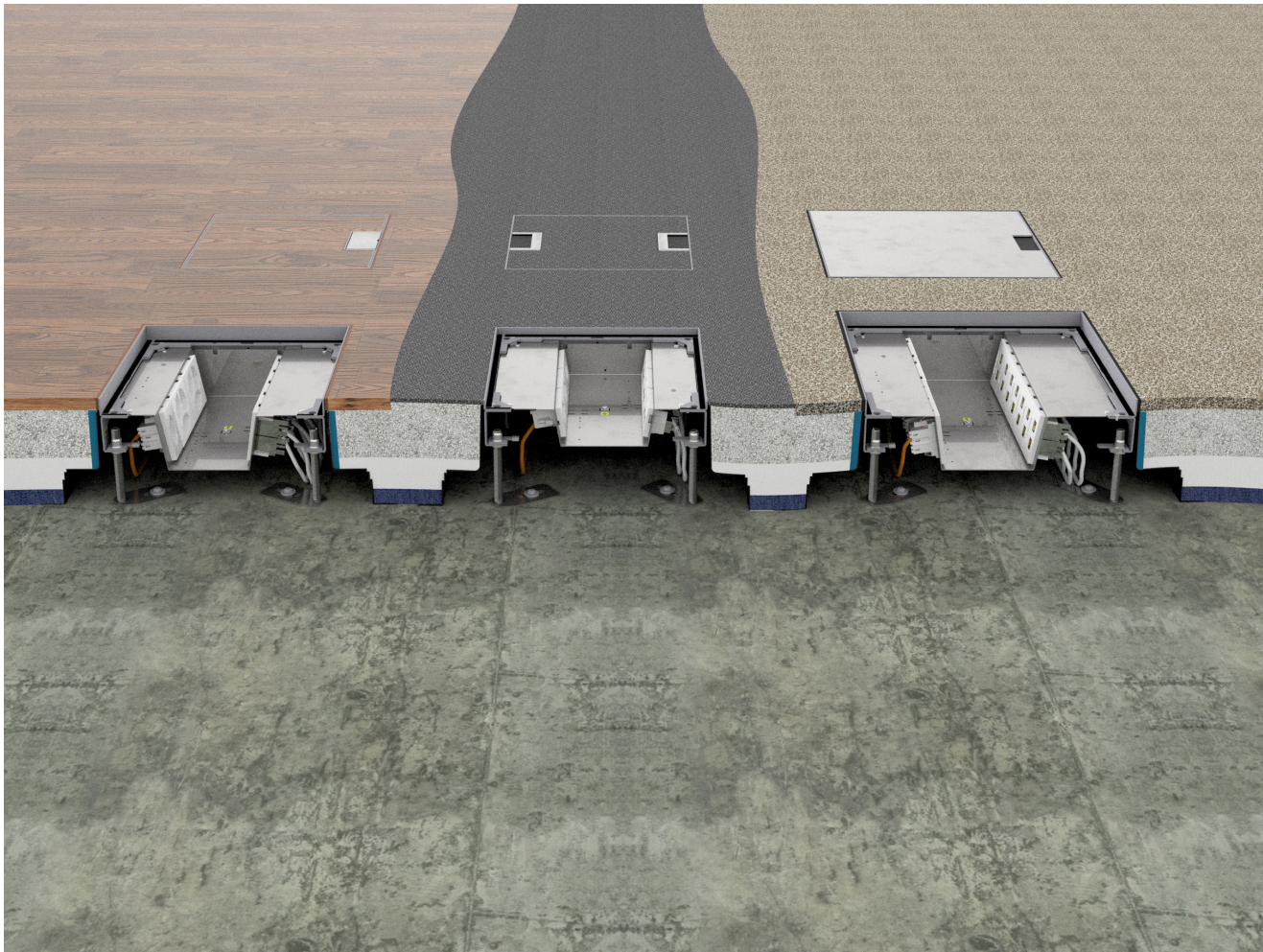

- Minimaler Bodenaufbau ab 62mm mit 5mm Vertiefung im Deckel (Isolation + Unterlagsboden + Bodenbelag)
- Mit innenliegenden Nivellierschrauben
- Rahmen, Deckel mit Kante, Auslass und Steckdoseneinsatz aus Chromstahl
- Unterteil, Deckel flach und Nivellierschrauben aus SVZ (sendzimir-verzinkter Stahl)



	Kunststoff-Einbaubox, schwarz, halogenfrei (siehe Datenblatt) oben: 220/270mm unten: 420/420mm H: 150mm
<b>UBD 260 283</b>	Höhe: 150mm
<b>UBD 260 284</b>	Höhe: 192mm

	Aufstock-Rahmen aus SVZ inkl. Nivellierschrauben zu UBD 260 und 320, UFK bis 375
<b>UBD 260 320</b>	bis 95mm, mit EBB: bis 275mm
<b>UBD 260 321</b>	bis 170mm, mit EBB: bis 350mm

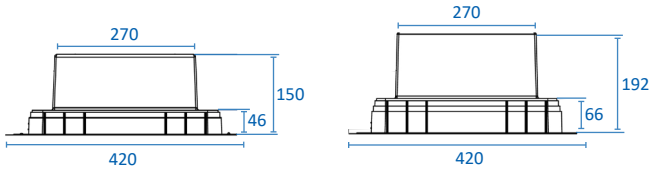

	Trittschall-Unterlage 3mm, für Einbaubox  Set à 4 Stk.  <b>UBD 001 001</b>
---	--

### Details UBD 260 320

#### Einbaubox Höhe 150mm

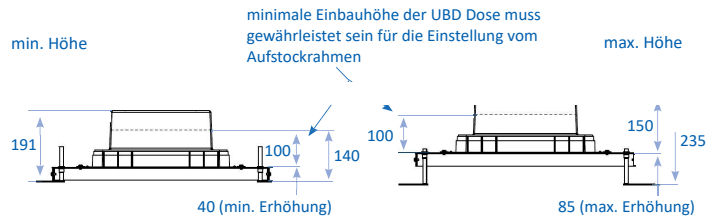

#### Einbaubox Höhe 192mm

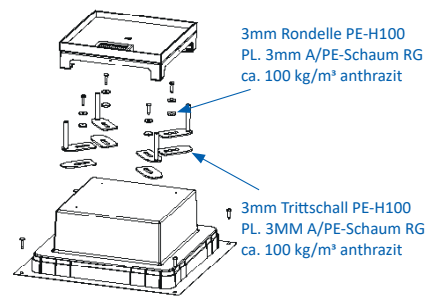
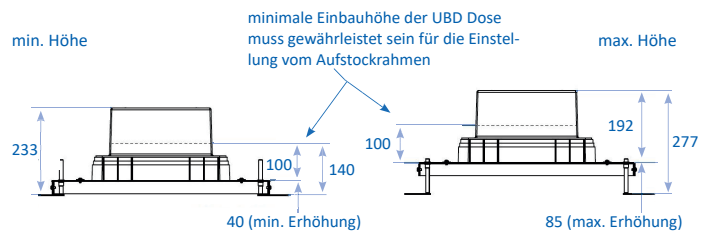

### Details UBD 260 321

#### Einbaubox Höhe 150mm

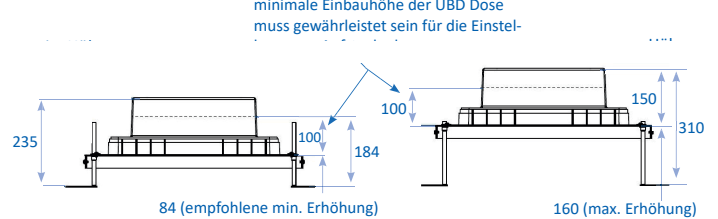

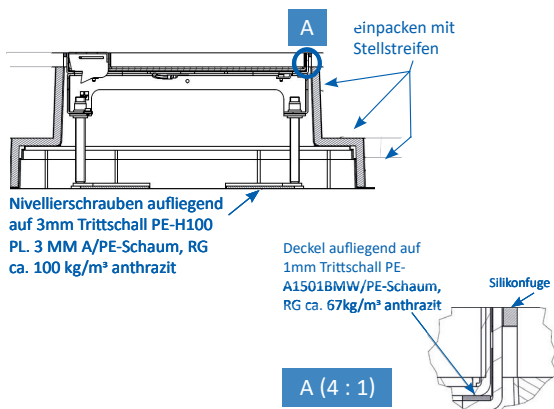
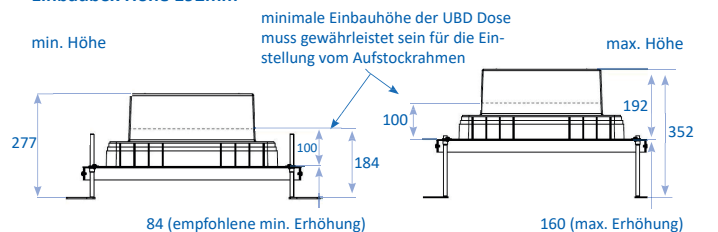

#### Einbaubox Höhe 192mm





## mit 5mm Vertiefung

	Unterflur-Bodendose UBD 260 aus Chromstahl inkl. Deckel, flach (SVZ), ohne Kante, 5mm Vertiefung und 1 Schnurauslass
<b>UBD 262 255</b>	

	Unterflur-Bodendose UBD 260 aus Chromstahl inkl. Deckel, flach (SVZ), ohne Kante, 5mm Vertiefung und 2 Schnurauslässe
<b>UBD 262 257</b>	

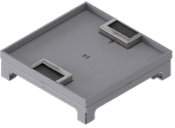
	Unterflur-Bodendose UBD 260 aus Chromstahl inkl. Deckel, flach (SVZ), ohne Kante, 5mm Vertiefung und 1 Bürstenauslass
<b>UBD 262 256</b>	

	Unterflur-Bodendose UBD 260 aus Chromstahl inkl. Deckel, flach (SVZ), ohne Kante, 5mm Vertiefung und 2 Bürstenauslässe
<b>UBD 262 258</b>	

	Unterflur-Bodendose UBD 260 aus Chromstahl inkl. Blinddeckel, flach (SVZ), ohne Kante, 5mm Vertiefung
<b>UBD 262 259</b>	

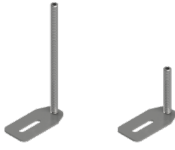
	Nivellierschrauben, Set à 4 Stk.
	Nivellierbereich von Roh- bis Fertigboden
<b>UBD 002 045</b>	62 - 88mm
<b>UBD 002 070</b>	83 - 113mm
<b>UBD 002 095</b>	108 - 138mm
<b>UBD 002 120</b>	1133 - 163mm
<b>UBD 002 145</b>	158 - 188mm
<b>UBD 002 170</b>	183 - 213mm

## mit 15mm Vertiefung

	Unterflur-Bodendose UBD 260 aus Chromstahl inkl. Deckel mit Kante, geschlossen, 15mm Vertiefung und 1 Schnurauslass
<b>UBD 260 255</b>	

	Unterflur-Bodendose UBD 260 aus Chromstahl inkl. Deckel mit Kante, geschlossen, 15mm Vertiefung und 2 Schnurauslässe
<b>UBD 260 257</b>	

	Unterflur-Bodendose UBD 260 aus Chromstahl inkl. Deckel mit Kante, geschlossen, 15mm Vertiefung und 1 Bürstenauslass
<b>UBD 260 256</b>	

	Unterflur-Bodendose UBD 260 aus Chromstahl inkl. Deckel mit Kante, geschlossen, 15mm Vertiefung und 2 Bürstenauslässe
<b>UBD 260 258</b>	

	Unterflur-Bodendose UBD 260 aus Chromstahl inkl. Blinddeckel mit Kante, geschlossen, und 15mm Vertiefung
<b>UBD 260 259</b>	

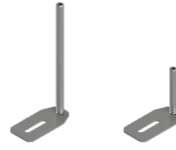
	Nivellierschrauben, Set à 4 Stk.
	Nivellierbereich von Roh- bis Fertigboden
<b>UBD 002 045</b>	72 - 98mm
<b>UBD 002 070</b>	93 - 123mm
<b>UBD 002 095</b>	118 - 148mm
<b>UBD 002 120</b>	143 - 173mm
<b>UBD 002 145</b>	168 - 198mm
<b>UBD 002 170</b>	193 - 223mm







## mit 20mm Vertiefung

	Unterflur-Bodendose UBD 260 aus Chromstahl inkl. Deckel mit Kante, geschlossen, 20mm Vertiefung und 1 Schnurauslass
<b>UBD 264 201</b>	

	Unterflur-Bodendose UBD 260 aus Chromstahl inkl. Deckel mit Kante, geschlossen, 20mm Vertiefung und 2 Schnurauslässen
<b>UBD 264 203</b>	

	Unterflur-Bodendose UBD 260 aus Chromstahl inkl. Deckel mit Kante, geschlossen, 20mm Vertiefung und 1 Bürstenauslass
<b>UBD 264 202</b>	

	Unterflur-Bodendose UBD 260 aus Chromstahl inkl. Deckel mit Kante, geschlossen, 20mm Vertiefung und 2 Bürstenauslässen
<b>UBD 264 204</b>	

	Unterflur-Bodendose UBD 260 aus Chromstahl inkl. Blinddeckel mit Kante, geschlossen, und 20mm Vertiefung
<b>UBD 264 205</b>	

## mit 25mm Vertiefung

	Unterflur-Bodendose UBD 260 aus Chromstahl inkl. Deckel mit Kante, geschlossen, 25mm Vertiefung und 1 Schnurauslass
<b>UBD 264 251</b>	

	Unterflur-Bodendose UBD 260 aus Chromstahl inkl. Deckel mit Kante, geschlossen, 25mm Vertiefung und 2 Schnurauslässen
<b>UBD 264 253</b>	

	Unterflur-Bodendose UBD 260 aus Chromstahl inkl. Deckel mit Kante, geschlossen, 25mm Vertiefung und 1 Bürstenauslass
<b>UBD 264 252</b>	

	Unterflur-Bodendose UBD 260 aus Chromstahl inkl. Deckel mit Kante, geschlossen, 25mm Vertiefung und 2 Bürstenauslässen
<b>UBD 264 254</b>	

	Unterflur-Bodendose UBD 260 aus Chromstahl inkl. Blinddeckel mit Kante, geschlossen, und 25mm Vertiefung
<b>UBD 264 255</b>	

	Nivellierschrauben, Set à 4 Stk.
	Nivellierbereich von Roh- bis Fertigboden
<b>UBD 002 045</b>	77 - 103mm
<b>UBD 002 070</b>	98 - 128mm
<b>UBD 002 095</b>	123 - 153mm
<b>UBD 002 120</b>	148 - 178mm
<b>UBD 002 145</b>	173 - 203mm
<b>UBD 002 170</b>	198 - 228mm

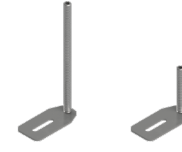
	Nivellierschrauben, Set à 4 Stk.
	Nivellierbereich von Roh- bis Fertigboden
<b>UBD 002 045</b>	82 - 108mm
<b>UBD 002 070</b>	103 - 133mm
<b>UBD 002 095</b>	128 - 158mm
<b>UBD 002 120</b>	153 - 183mm
<b>UBD 002 145</b>	178 - 208mm
<b>UBD 002 170</b>	203 - 233mm

## mit 30mm Vertiefung

	Unterflur-Bodendose UBD 260 aus Chromstahl inkl. Deckel mit Kante, geschlossen, 30mm Vertiefung und 1 Schnurauslass
<b>UBD 264 301</b>	

	Unterflur-Bodendose UBD 260 aus Chromstahl inkl. Deckel mit Kante, geschlossen, 30mm Vertiefung und 2 Schnurauslässen
<b>UBD 264 303</b>	

	Unterflur-Bodendose UBD 260 aus Chromstahl inkl. Deckel mit Kante, geschlossen, 30mm Vertiefung und 1 Bürstenauslass
<b>UBD 264 302</b>	

	Unterflur-Bodendose UBD 260 aus Chromstahl inkl. Deckel mit Kante, geschlossen, 30mm Vertiefung und 2 Bürstenauslässen
<b>UBD 264 304</b>	

	Unterflur-Bodendose UBD 260 aus Chromstahl inkl. Blinddeckel mit Kante, geschlossen, und 30mm Vertiefung
<b>UBD 264 305</b>	

## Chromstahl geschliffen

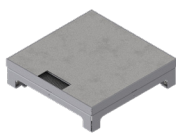
	Unterflur-Bodendose UBD 260 aus Chromstahl inkl. belegtem Deckel mit 1 Bürstenauslass
<b>UBD 260 251</b>	

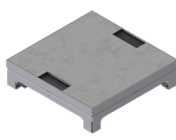
	Unterflur-Bodendose UBD 260 aus Chromstahl inkl. belegtem Deckel mit 2 Bürstenauslässen
<b>UBD 260 252</b>	

	Unterflur-Bodendose UBD 260 aus Chromstahl inkl. belegtem Blinddeckel
<b>UBD 260 253</b>	

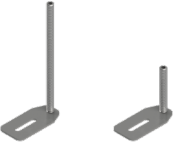
	Nivellierschrauben, Set à 4 Stk.
	Nivellierbereich von Roh- bis Fertigboden
<b>UBD 002 045</b>	87 - 113mm
<b>UBD 002 070</b>	108 - 138mm
<b>UBD 002 095</b>	133 - 163mm
<b>UBD 002 120</b>	158 - 188mm
<b>UBD 002 145</b>	183 - 213mm
<b>UBD 002 170</b>	208 - 238mm

	Nivellierschrauben, Set à 4 Stk.
	Nivellierbereich von Roh- bis Fertigboden
<b>UBD 002 045</b>	72 - 98mm
<b>UBD 002 070</b>	93 - 123mm
<b>UBD 002 095</b>	118 - 148mm
<b>UBD 002 120</b>	143 - 173mm
<b>UBD 002 145</b>	168 - 198mm
<b>UBD 002 170</b>	193 - 223mm

## Steckdoseneinsatz für 2x3 FLF ab 62mm, mit 5mm Vertiefung im Deckel

horizontal

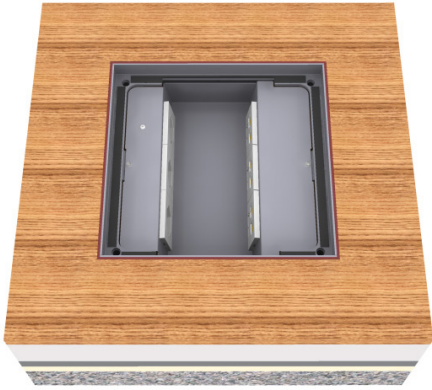

## Steckdoseneinsatz für 2x5 FLF ab 84mm, mit 5mm Vertiefung im Deckel

vertikal

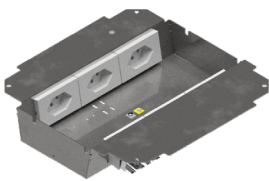
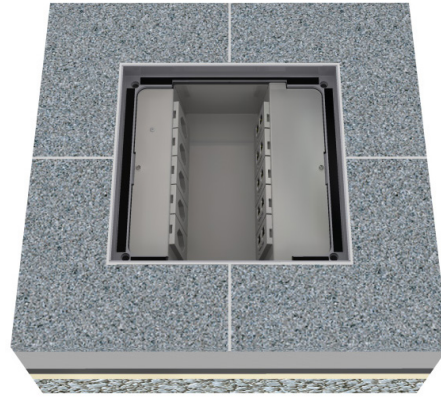

3x 1xT13 weiss

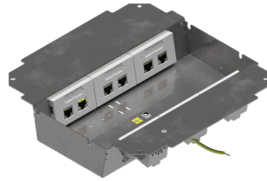

3x 2xRJ45

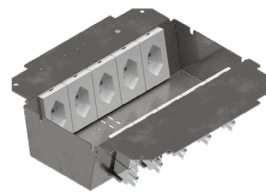

5x 1xT13 weiss

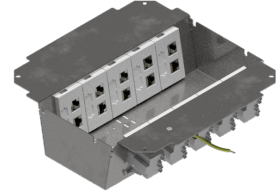

5x 2xRJ45

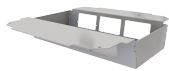

Steckdoseneinsatz für 2x3 FLF inkl.  
Erddraht, leer

UBD 260 265

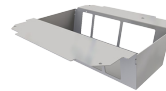

Steckdoseneinsatz für 2x5 FLF  
inkl. Erddraht, leer

UBD 260 266

## Modul 45x45

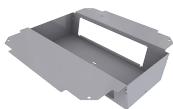

Steckdoseneinsatz mit 2x 4x  
45x45-Ausschnitten, leer

UBD 261 290

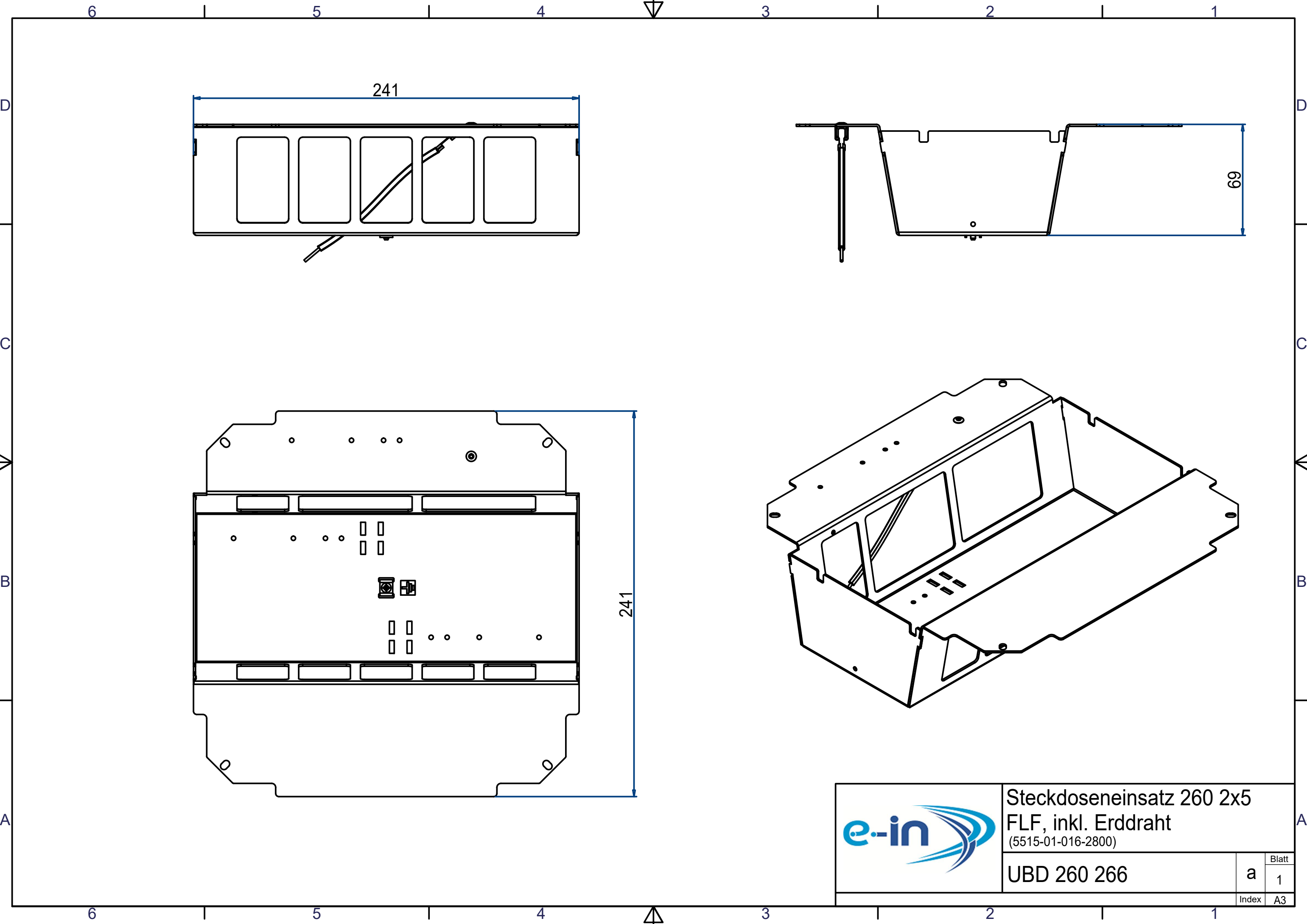

6 5 4 3 2 1

D D

C C

B B

A A

6 5 4 3 2 1

	<b>Steckdoseneinsatz 260 2x5</b> <b>FLF, inkl. Erddraht</b> (5515-01-016-2800)		Blatt
	<b>UBD 260 266</b>		1
		Index	A3

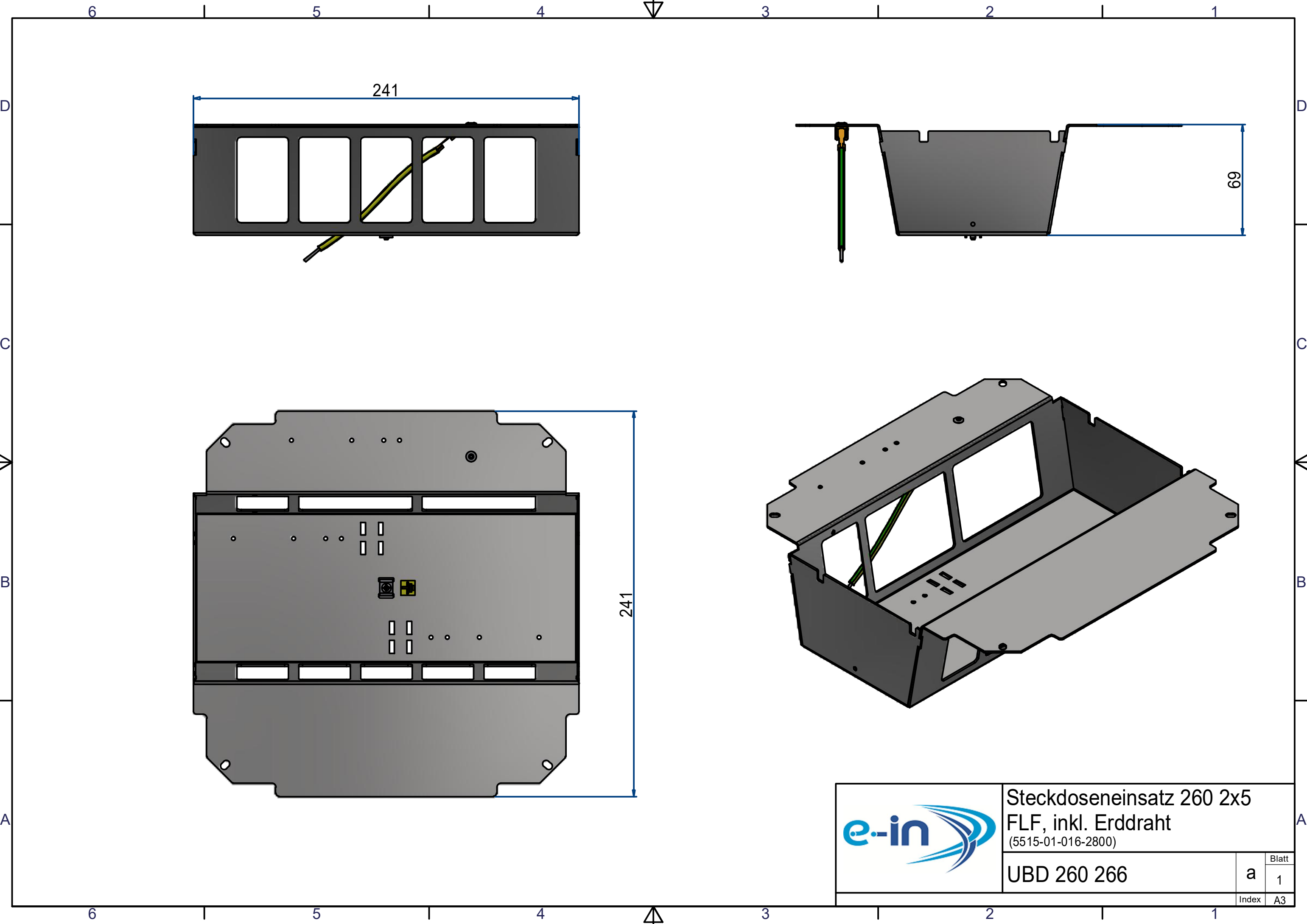

Steckdoseneinsatz 260 2x5  
 FLF, inkl. Erddraht  
 (5515-01-016-2800)







UBD 260 266

Blatt	1
Index	A3

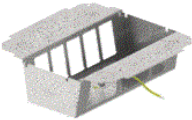
a

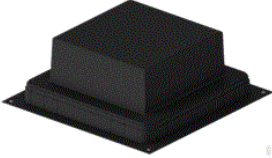

## Unterflur-Bodendose UBD 260 & UBD 320

↓ Benötigt	Optional ↓	
<b>Steckdoseneinsatz</b>		
<b>Unterflur-Bodendose UBD</b>		
<b>Nivellierschrauben</b>		
		<b>Trittschall-Unterlage (optional)</b>
<b>Kunststoff-Einbaubox</b>		
		<b>Aufstockrahmen (optional)</b>

### Anmerkung

1. Etappe: Kunststoff-Einbaubox, Aufstockrahmen
2. Etappe: Unterflur-Bodendose UBD, Nivellierschrauben, Trittschall-Unterlage, Steckdoseneinsatz