

Unterflur-Bodendose UBD 320 aus Chromstahl



- Minimaler Bodenaufbau ab 62mm mit 5mm Vertiefung im Deckel (Isolation + Unterlagsboden + Bodenbelag)
- Mit innenliegenden Nivellierschrauben
- Rahmen, Deckel mit Kante, Auslass und Steckdoseneinsatz aus Chromstahl
- Unterteil, Deckel flach und Nivellierschrauben aus SVZ (sendzimir-verzinkter Stahl)



	Kunststoff-Einbaubox, schwarz, halogenfrei (siehe Datenblatt) oben: 330/330mm unten: 508/508mm H: 150mm
UBD 320 356	Höhe: 150mm
UBD 320 357	Höhe: 192mm

	Aufstock-Rahmen aus SVZ inkl. Nivellierschrauben zu UBD 260 und 320, UFK bis 375
UBD 260 320	bis 95mm, mit EBB: bis 275mm
UBD 260 321	bis 170mm, mit EBB: bis 350mm

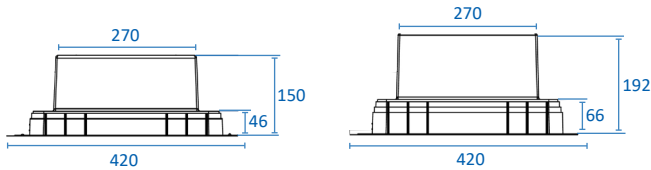

	Trittschall-Unterlage 3mm, für Einbaubox Set à 4 Stk.
UBD 001 001	

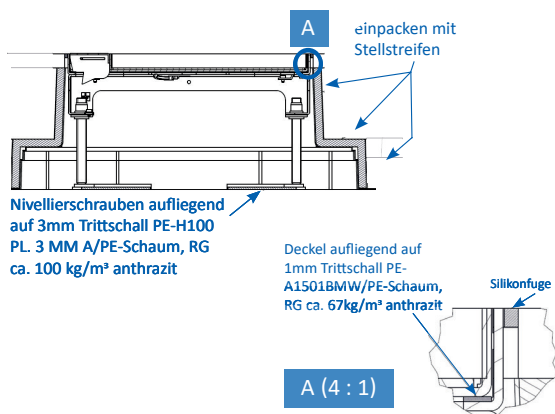
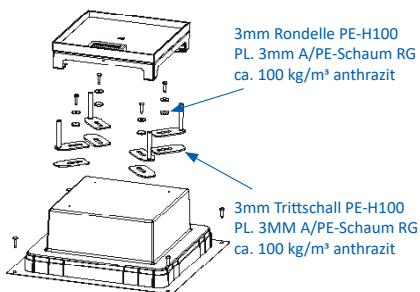

Details UBD 260 320

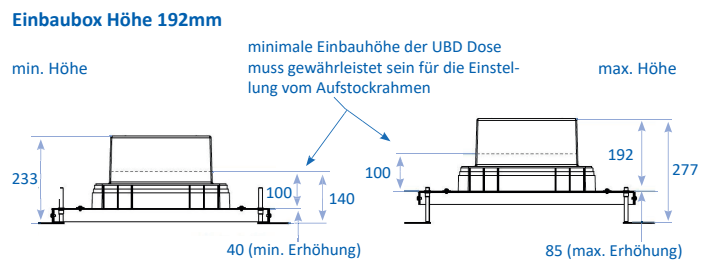
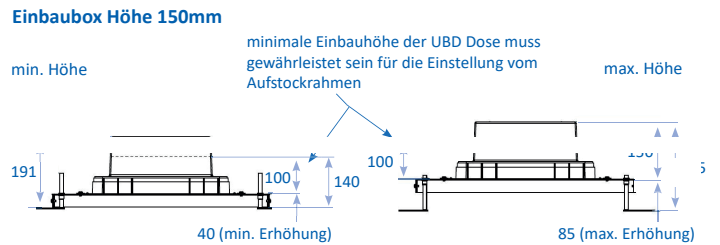

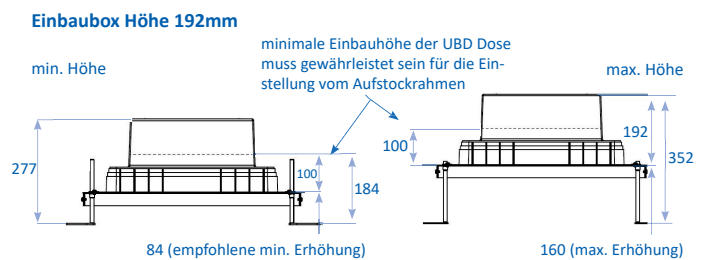
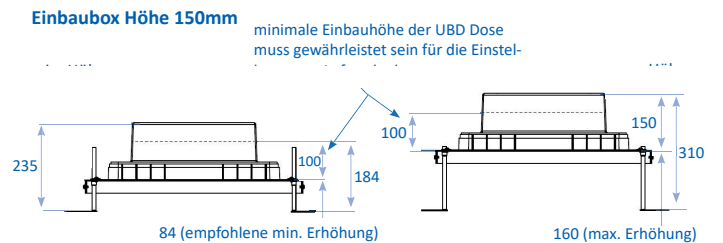

Details UBD 260 321





mit 5mm Vertiefung

	Unterflur-Bodendose UBD 320 aus Chromstahl inkl. Deckel, flach (SVZ), ohne Kante, 5mm Vertiefung und 1 Schnurauslass
UBD 322 315	

	Unterflur-Bodendose UBD 320 aus Chromstahl inkl. Deckel, flach (SVZ), ohne Kante, 5mm Vertiefung und 2 Schnurauslässe
UBD 322 317	

	Unterflur-Bodendose UBD 320 aus Chromstahl inkl. Deckel, flach (SVZ), ohne Kante, 5mm Vertiefung und 1 Bürstenauslass
UBD 322 316	

	Unterflur-Bodendose UBD 320 aus Chromstahl inkl. Deckel, flach (SVZ), ohne Kante, 5mm Vertiefung und 2 Bürstenauslässe
UBD 322 318	

	Unterflur-Bodendose UBD 320 aus Chromstahl inkl. Blinddeckel, flach (SVZ), ohne Kante, 5mm Vertiefung
UBD 322 319	

	Nivellierschrauben, Set à 4 Stk.
	Nivellierbereich von Roh- bis Fertigboden
UBD 002 045	62 - 88mm
UBD 002 070	83 - 113mm
UBD 002 095	108 - 138mm
UBD 002 120	133 - 163mm
UBD 002 145	158 - 188mm
UBD 002 170	183 - 213mm

mit 15mm Vertiefung

	Unterflur-Bodendose UBD 320 aus Chromstahl inkl. Deckel mit Kante, geschlossen, 15mm Vertiefung und 1 Schnurauslass
UBD 320 315	

	Unterflur-Bodendose UBD 320 aus Chromstahl inkl. Deckel mit Kante, geschlossen, 15mm Vertiefung und 2 Schnurauslässe
UBD 320 317	

	Unterflur-Bodendose UBD 320 aus Chromstahl inkl. Deckel mit Kante, geschlossen, 15mm Vertiefung und 1 Bürstenauslass
UBD 320 316	

	Unterflur-Bodendose UBD 320 aus Chromstahl inkl. Deckel mit Kante, geschlossen, 15mm Vertiefung und 2 Bürstenauslässe
UBD 320 318	

	Unterflur-Bodendose UBD 320 aus Chromstahl inkl. Blinddeckel mit Kante, geschlossen, und 15mm Vertiefung
UBD 320 319	

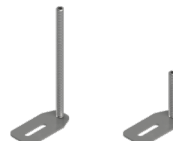
	Nivellierschrauben, Set à 4 Stk.
	Nivellierbereich von Roh- bis Fertigboden
UBD 002 045	72 - 98mm
UBD 002 070	93 - 123mm
UBD 002 095	118 - 148mm
UBD 002 120	143 - 173mm
UBD 002 145	168 - 198mm
UBD 002 170	193 - 223mm





mit 20mm Vertiefung

	Unterflur-Bodendose UBD 320 aus Chromstahl inkl. Deckel mit Kante, geschlossen, 20mm Vertiefung und 1 Schnurauslass
UBD 324 201	

	Unterflur-Bodendose UBD 320 aus Chromstahl inkl. Deckel mit Kante, geschlossen, 20mm Vertiefung und 2 Schnurauslässe
UBD 324 203	

	Unterflur-Bodendose UBD 320 aus Chromstahl inkl. Deckel mit Kante, geschlossen, 20mm Vertiefung und 1 Bürstenauslass
UBD 324 202	

	Unterflur-Bodendose UBD 320 aus Chromstahl inkl. Deckel mit Kante, geschlossen, 20mm Vertiefung und 2 Bürstenauslässe
UBD 324 204	

	Unterflur-Bodendose UBD 320 aus Chromstahl inkl. Blinddeckel mit Kante, geschlossen, und 20mm Vertiefung
UBD 324 205	

	Nivellierschrauben, Set à 4 Stk.
	Nivellierbereich von Roh- bis Fertigboden
UBD 002 045	77 - 103mm
UBD 002 070	98 - 128mm
UBD 002 095	123 - 153mm
UBD 002 120	148 - 178mm
UBD 002 145	173 - 203mm
UBD 002 170	198 - 228mm

mit 25mm Vertiefung

	Unterflur-Bodendose UBD 320 aus Chromstahl inkl. Deckel mit Kante, geschlossen, 25mm Vertiefung und 1 Schnurauslass
UBD 324 251	

	Unterflur-Bodendose UBD 320 aus Chromstahl inkl. Deckel mit Kante, geschlossen, 25mm Vertiefung und 2 Schnurauslässe
UBD 324 253	

	Unterflur-Bodendose UBD 320 aus Chromstahl inkl. Deckel mit Kante, geschlossen, 25mm Vertiefung und 1 Bürstenauslass
UBD 324 252	

	Unterflur-Bodendose UBD 320 aus Chromstahl inkl. Deckel mit Kante, geschlossen, 25mm Vertiefung und 2 Bürstenauslässe
UBD 324 254	

	Unterflur-Bodendose UBD 320 aus Chromstahl inkl. Deckel mit Kante, geschlossen, 25mm Vertiefung und 2 Bürstenauslässe
UBD 324 255	

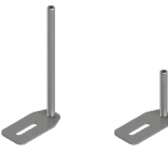
	Nivellierschrauben, Set à 4 Stk.
	Nivellierbereich von Roh- bis Fertigboden
UBD 002 045	82 - 108mm
UBD 002 070	103 - 133mm
UBD 002 095	128 - 158mm
UBD 002 120	153 - 183mm
UBD 002 145	178 - 208mm
UBD 002 170	203 - 233mm

mit 30mm Vertiefung

	Unterflur-Bodendose UBD 320 aus Chromstahl inkl. Deckel mit Kante, geschlossen, 30mm Vertiefung und 1 Schnurauslass
UBD 324 301	

	Unterflur-Bodendose UBD 320 aus Chromstahl inkl. Deckel mit Kante, geschlossen, 30mm Vertiefung und 2 Schnurauslässen
UBD 324 303	

	Unterflur-Bodendose UBD 320 aus Chromstahl inkl. Deckel mit Kante, geschlossen, 30mm Vertiefung und 1 Bürstenauslass
UBD 324 302	

	Unterflur-Bodendose UBD 320 aus Chromstahl inkl. Deckel mit Kante, geschlossen, 30mm Vertiefung und 2 Bürstenauslässen
UBD 324 304	

	Unterflur-Bodendose UBD 320 aus Chromstahl inkl. Blinddeckel mit Kante, geschlossen, und 30mm Vertiefung
UBD 324 305	

Chromstahl geschliffen

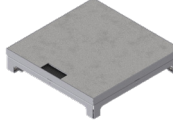
	Unterflur-Bodendose UBD 320 aus Chromstahl inkl. belegtem Deckel und 1 Bürstenauslass
UBD 320 311	

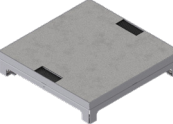
	Unterflur-Bodendose UBD 320 aus Chromstahl inkl. belegtem Deckel und 2 Bürstenauslässen
UBD 320 312	

	Unterflur-Bodendose UBD 320 aus Chromstahl inkl. belegtem Blinddeckel
UBD 320 313	

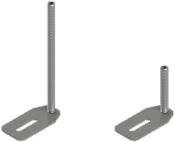
	Nivellierschrauben, Set à 4 Stk.
	Nivellierbereich von Roh- bis Fertigboden
UBD 002 045	87 - 113mm
UBD 002 070	108 - 138mm
UBD 002 095	133 - 163mm
UBD 002 120	158 - 188mm
UBD 002 145	183 - 213mm
UBD 002 170	208 - 238mm

	Nivellierschrauben, Set à 4 Stk.
	Nivellierbereich von Roh- bis Fertigboden
UBD 002 045	72- 98mm
UBD 002 070	93 - 123mm
UBD 002 095	118 - 148mm
UBD 002 120	143 - 173mm
UBD 002 145	168 - 198mm
UBD 002 170	193 - 223mm



Steckdoseneinsatz für 2x4 FLF ab 62mm, mit 5mm Vertiefung im Deckel

horizontal

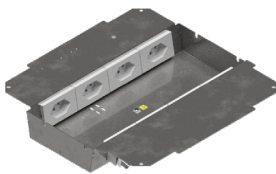
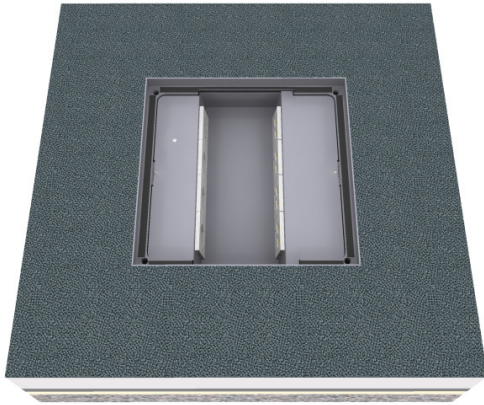

4x 1xT13 weiss

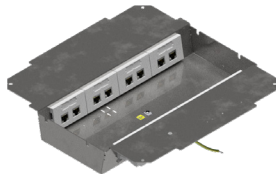

4x 2xRJ45

Steckdoseneinsatz für 2x7 FLF ab 84mm, mit 5mm Vertiefung im Deckel

vertikal

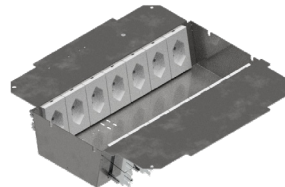
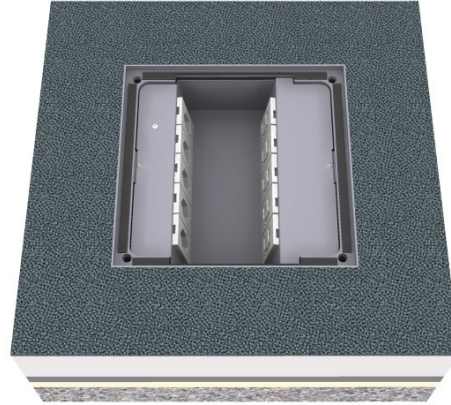

7x 1xT13 weiss

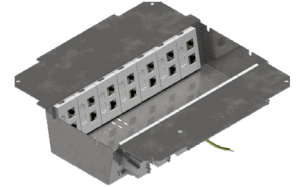

7x 2xRJ45



Steckdoseneinsatz für 2x4 FLF inkl.
Erddraht, leer

UBD 320 325

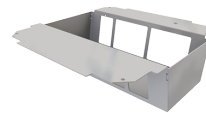

Steckdoseneinsatz für 2x7 FLF
inkl. Erddraht, leer

UBD 320 326

Modul 45x45

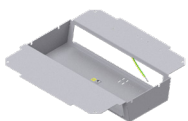

Steckdoseneinsatz mit 2x 6x
45x45-Ausschnitten, leer

UBD 321 339

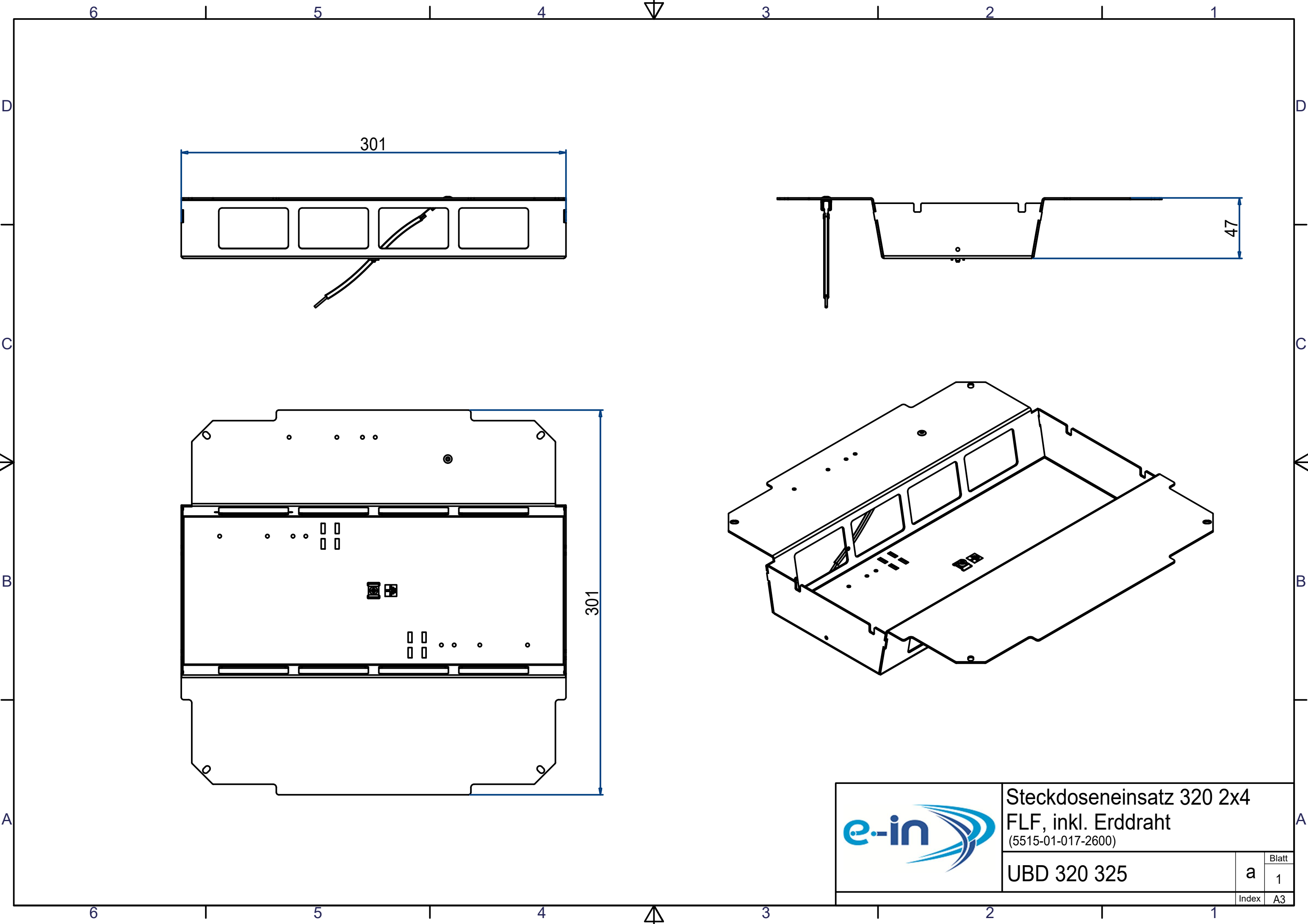

Steckdoseneinsatz 320 2x4
 FLF, inkl. Erddraht
 (5515-01-017-2600)

UBD 320 325	Blatt	1
	Index	A3

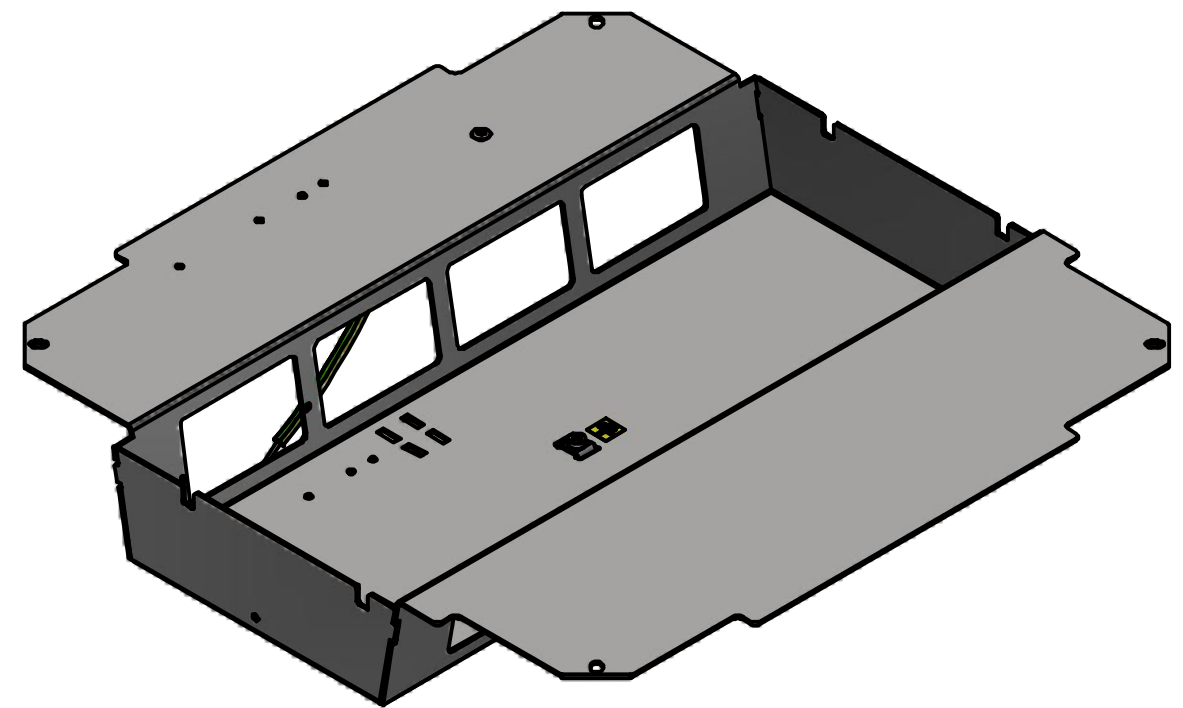
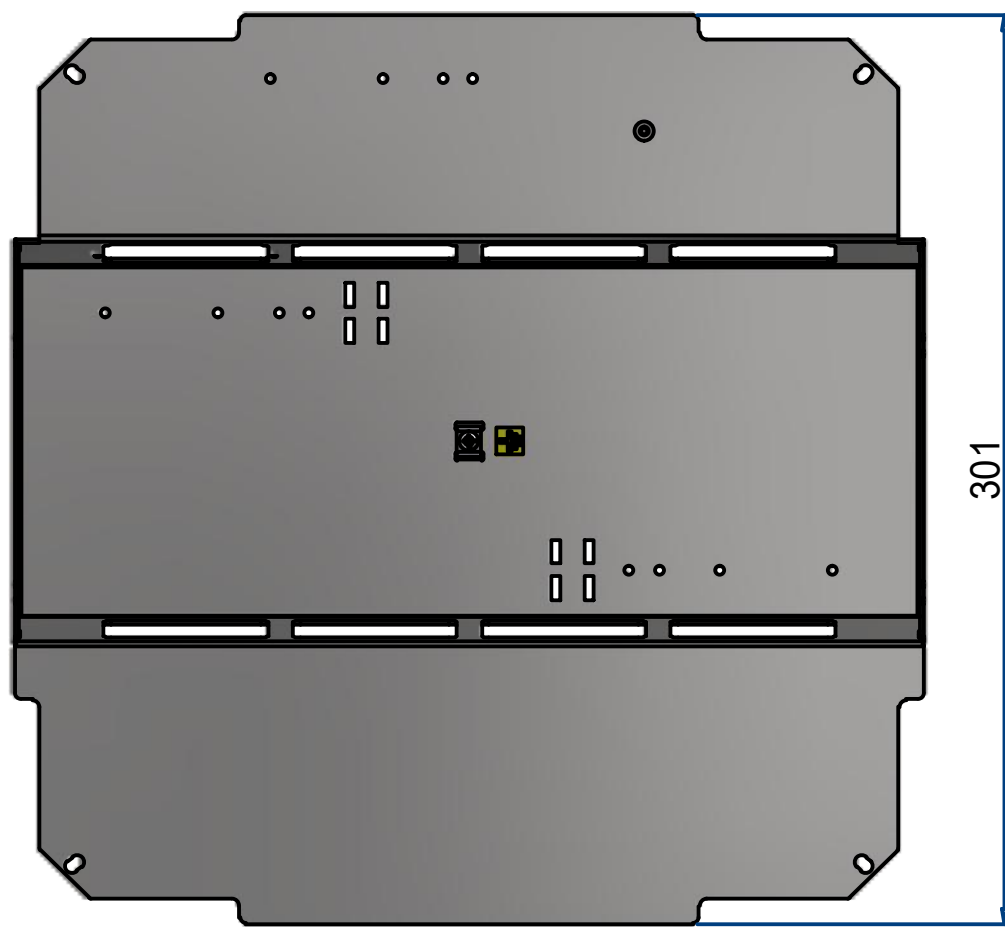
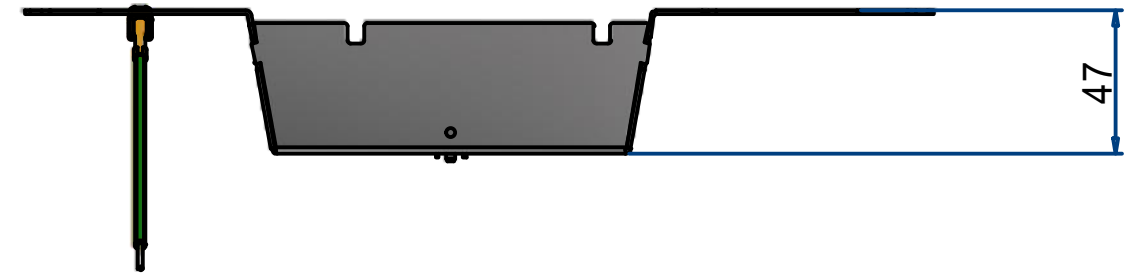
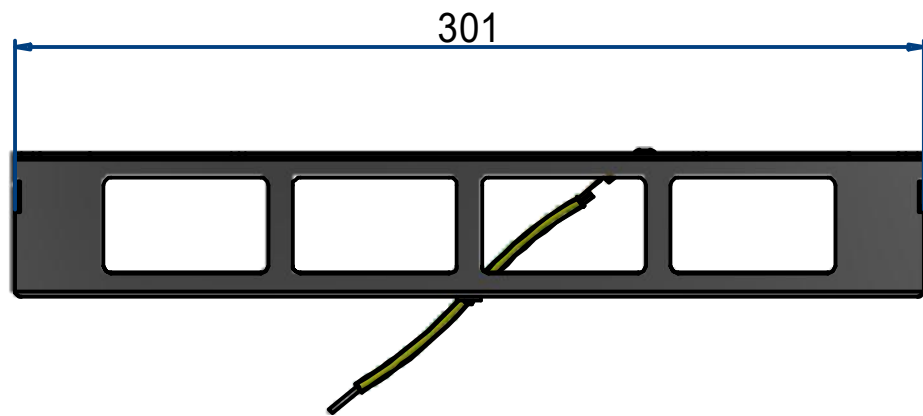







Steckdoseneinsatz 320 2x4
 FLF, inkl. Erddraht
 (5515-01-017-2600)

UBD 320 325

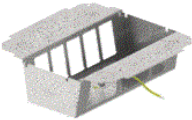
Blatt	1
Index	A3

a

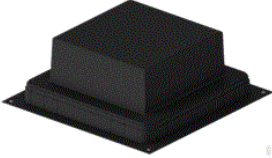
Unterflur-Bodendose UBD 260 & UBD 320

↓ Benötigt	Optional ↓
Steckdoseneinsatz	
Unterflur-Bodendose UBD	
Nivellierschrauben	
	 Trittschall-Unterlage (optional)
Kunststoff-Einbaubox	
	 Aufstockrahmen (optional)

Anmerkung

1. Etappe: Kunststoff-Einbaubox, Aufstockrahmen
2. Etappe: Unterflur-Bodendose UBD, Nivellierschrauben, Trittschall-Unterlage, Steckdoseneinsatz