

## Unterflur-Bodendose UBD 320 aus Chromstahl

---



- Minimaler Bodenaufbau ab 62mm mit 5mm Vertiefung im Deckel (Isolation + Unterlagsboden + Bodenbelag)
- Mit innenliegenden Nivellierschrauben
- Rahmen, Deckel mit Kante, Auslass und Steckdoseneinsatz aus Chromstahl
- Unterteil, Deckel flach und Nivellierschrauben aus SVZ (sendzimir-verzinkter Stahl)



	Kunststoff-Einbaubox, schwarz, halogenfrei (siehe Datenblatt) oben: 330/330mm unten: 508/508mm H: 150mm
<b>UBD 320 356</b>	Höhe: 150mm
<b>UBD 320 357</b>	Höhe: 192mm

	Aufstock-Rahmen aus SVZ inkl. Nivellierschrauben zu UBD 260 und 320, UFK bis 375
<b>UBD 260 320</b>	bis 95mm, mit EBB: bis 275mm
<b>UBD 260 321</b>	bis 170mm, mit EBB: bis 350mm

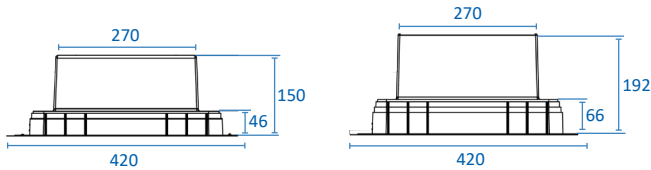

	Trittschall-Unterlage 3mm, für Einbaubox Set à 4 Stk.
<b>UBD 001 001</b>	

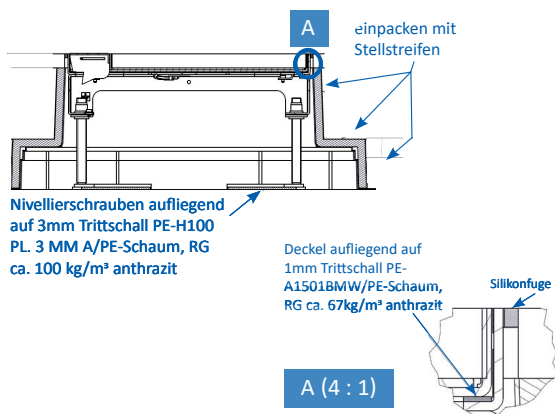
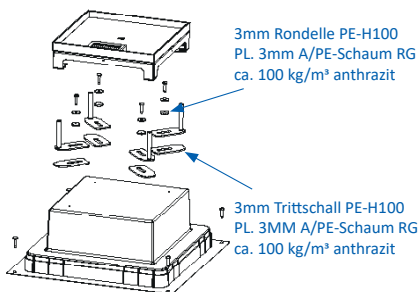

### Details UBD 260 320

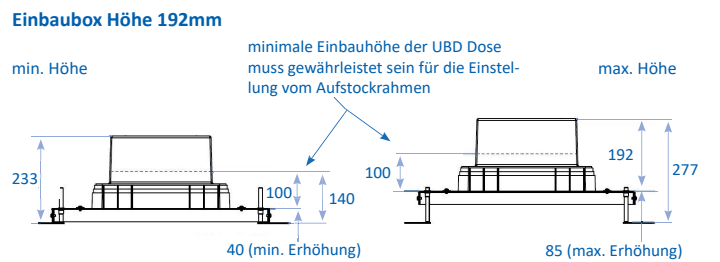
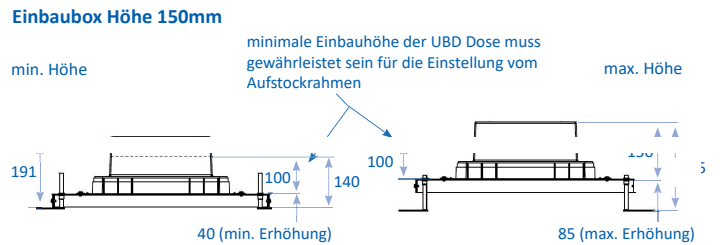

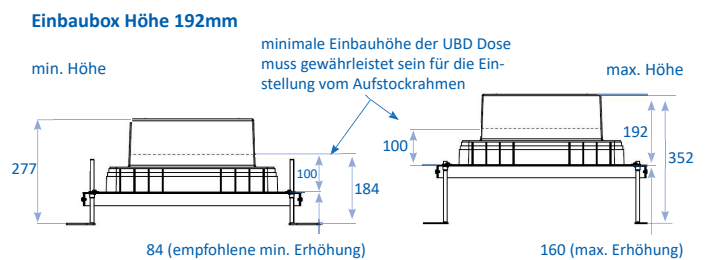
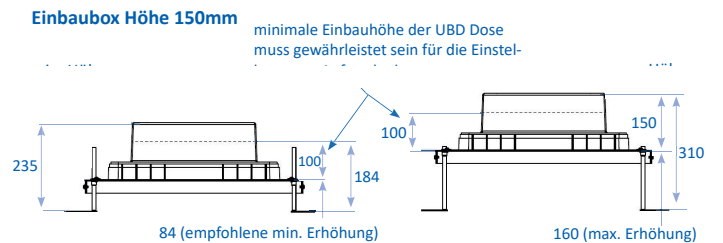

### Details UBD 260 321





## mit 5mm Vertiefung

	Unterflur-Bodendose UBD 320 aus Chromstahl inkl. Deckel, flach (SVZ), ohne Kante, 5mm Vertiefung und 1 Schnurauslass
<b>UBD 322 315</b>	

	Unterflur-Bodendose UBD 320 aus Chromstahl inkl. Deckel, flach (SVZ), ohne Kante, 5mm Vertiefung und 2 Schnurauslässen
<b>UBD 322 317</b>	

	Unterflur-Bodendose UBD 320 aus Chromstahl inkl. Deckel, flach (SVZ), ohne Kante, 5mm Vertiefung und 1 Bürstenauslass
<b>UBD 322 316</b>	

	Unterflur-Bodendose UBD 320 aus Chromstahl inkl. Deckel, flach (SVZ), ohne Kante, 5mm Vertiefung und 2 Bürstenauslässen
<b>UBD 322 318</b>	

	Unterflur-Bodendose UBD 320 aus Chromstahl inkl. Blinddeckel, flach (SVZ), ohne Kante, 5mm Vertiefung
<b>UBD 322 319</b>	

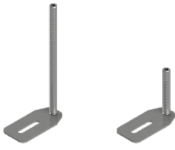
	Nivellierschrauben, Set à 4 Stk.
	Nivellierbereich von Roh- bis Fertigboden
<b>UBD 002 045</b>	62 - 88mm
<b>UBD 002 070</b>	83 - 113mm
<b>UBD 002 095</b>	108 - 138mm
<b>UBD 002 120</b>	133 - 163mm
<b>UBD 002 145</b>	158 - 188mm
<b>UBD 002 170</b>	183 - 213mm

## mit 15mm Vertiefung

	Unterflur-Bodendose UBD 320 aus Chromstahl inkl. Deckel mit Kante, geschlossen, 15mm Vertiefung und 1 Schnurauslass
<b>UBD 320 315</b>	

	Unterflur-Bodendose UBD 320 aus Chromstahl inkl. Deckel mit Kante, geschlossen, 15mm Vertiefung und 2 Schnurauslässen
<b>UBD 320 317</b>	

	Unterflur-Bodendose UBD 320 aus Chromstahl inkl. Deckel mit Kante, geschlossen, 15mm Vertiefung und 1 Bürstenauslass
<b>UBD 320 316</b>	

	Unterflur-Bodendose UBD 320 aus Chromstahl inkl. Deckel mit Kante, geschlossen, 15mm Vertiefung und 2 Bürstenauslässen
<b>UBD 320 318</b>	

	Unterflur-Bodendose UBD 320 aus Chromstahl inkl. Blinddeckel mit Kante, geschlossen, und 15mm Vertiefung
<b>UBD 320 319</b>	

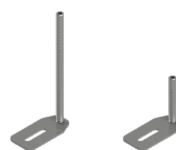
	Nivellierschrauben, Set à 4 Stk.
	Nivellierbereich von Roh- bis Fertigboden
<b>UBD 002 045</b>	72 - 98mm
<b>UBD 002 070</b>	93 - 123mm
<b>UBD 002 095</b>	118 - 148mm
<b>UBD 002 120</b>	143 - 173mm
<b>UBD 002 145</b>	168 - 198mm
<b>UBD 002 170</b>	193 - 223mm





## mit 20mm Vertiefung

	Unterflur-Bodendose UBD 320 aus Chromstahl inkl. Deckel mit Kante, geschlossen, 20mm Vertiefung und 1 Schnurauslass
<b>UBD 324 201</b>	

	Unterflur-Bodendose UBD 320 aus Chromstahl inkl. Deckel mit Kante, geschlossen, 20mm Vertiefung und 2 Schnurauslässen
<b>UBD 324 203</b>	

	Unterflur-Bodendose UBD 320 aus Chromstahl inkl. Deckel mit Kante, geschlossen, 20mm Vertiefung und 1 Bürstenauslass
<b>UBD 324 202</b>	

	Unterflur-Bodendose UBD 320 aus Chromstahl inkl. Deckel mit Kante, geschlossen, 20mm Vertiefung und 2 Bürstenauslässen
<b>UBD 324 204</b>	

	Unterflur-Bodendose UBD 320 aus Chromstahl inkl. Blinddeckel mit Kante, geschlossen, und 20mm Vertiefung
<b>UBD 324 205</b>	

	Nivellierschrauben, Set à 4 Stk.
	Nivellierbereich von Roh- bis Fertigboden
<b>UBD 002 045</b>	77 - 103mm
<b>UBD 002 070</b>	98 - 128mm
<b>UBD 002 095</b>	123 - 153mm
<b>UBD 002 120</b>	148 - 178mm
<b>UBD 002 145</b>	173 - 203mm
<b>UBD 002 170</b>	198 - 228mm

## mit 25mm Vertiefung

	Unterflur-Bodendose UBD 320 aus Chromstahl inkl. Deckel mit Kante, geschlossen, 25mm Vertiefung und 1 Schnurauslass
<b>UBD 324 251</b>	

	Unterflur-Bodendose UBD 320 aus Chromstahl inkl. Deckel mit Kante, geschlossen, 25mm Vertiefung und 2 Schnurauslässen
<b>UBD 324 253</b>	

	Unterflur-Bodendose UBD 320 aus Chromstahl inkl. Deckel mit Kante, geschlossen, 25mm Vertiefung und 1 Bürstenauslass
<b>UBD 324 252</b>	

	Unterflur-Bodendose UBD 320 aus Chromstahl inkl. Deckel mit Kante, geschlossen, 25mm Vertiefung und 2 Bürstenauslässen
<b>UBD 324 254</b>	

	Unterflur-Bodendose UBD 320 aus Chromstahl inkl. Deckel mit Kante, geschlossen, 25mm Vertiefung und 2 Bürstenauslässen
<b>UBD 324 255</b>	

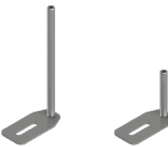
	Nivellierschrauben, Set à 4 Stk.
	Nivellierbereich von Roh- bis Fertigboden
<b>UBD 002 045</b>	82 - 108mm
<b>UBD 002 070</b>	103 - 133mm
<b>UBD 002 095</b>	128 - 158mm
<b>UBD 002 120</b>	153 - 183mm
<b>UBD 002 145</b>	178 - 208mm
<b>UBD 002 170</b>	203 - 233mm

## mit 30mm Vertiefung

	Unterflur-Bodendose UBD 320 aus Chromstahl inkl. Deckel mit Kante, geschlossen, 30mm Vertiefung und 1 Schnurauslass
<b>UBD 324 301</b>	

	Unterflur-Bodendose UBD 320 aus Chromstahl inkl. Deckel mit Kante, geschlossen, 30mm Vertiefung und 2 Schnurauslässe
<b>UBD 324 303</b>	

	Unterflur-Bodendose UBD 320 aus Chromstahl inkl. Deckel mit Kante, geschlossen, 30mm Vertiefung und 1 Bürstenauslass
<b>UBD 324 302</b>	

	Unterflur-Bodendose UBD 320 aus Chromstahl inkl. Deckel mit Kante, geschlossen, 30mm Vertiefung und 2 Bürstenauslässe
<b>UBD 324 304</b>	

	Unterflur-Bodendose UBD 320 aus Chromstahl inkl. Blinddeckel mit Kante, geschlossen, und 30mm Vertiefung
<b>UBD 324 305</b>	

## Chromstahl geschliffen

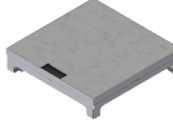
	Unterflur-Bodendose UBD 320 aus Chromstahl inkl. belegtem Deckel und 1 Bürstenauslass
<b>UBD 320 311</b>	

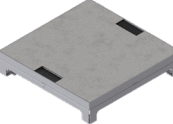
	Unterflur-Bodendose UBD 320 aus Chromstahl inkl. belegtem Deckel und 2 Bürstenauslässe
<b>UBD 320 312</b>	

	Unterflur-Bodendose UBD 320 aus Chromstahl inkl. belegtem Blinddeckel
<b>UBD 320 313</b>	

	Nivellierschrauben, Set à 4 Stk.
	Nivellierbereich von Roh- bis Fertigboden
<b>UBD 002 045</b>	87 - 113mm
<b>UBD 002 070</b>	108 - 138mm
<b>UBD 002 095</b>	133 - 163mm
<b>UBD 002 120</b>	158 - 188mm
<b>UBD 002 145</b>	183 - 213mm
<b>UBD 002 170</b>	208 - 238mm

	Nivellierschrauben, Set à 4 Stk.
	Nivellierbereich von Roh- bis Fertigboden
<b>UBD 002 045</b>	72- 98mm
<b>UBD 002 070</b>	93 - 123mm
<b>UBD 002 095</b>	118 - 148mm
<b>UBD 002 120</b>	143 - 173mm
<b>UBD 002 145</b>	168 - 198mm
<b>UBD 002 170</b>	193 - 223mm



## Steckdoseneinsatz für 2x4 FLF ab 62mm, mit 5mm Vertiefung im Deckel

horizontal

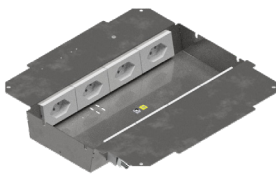
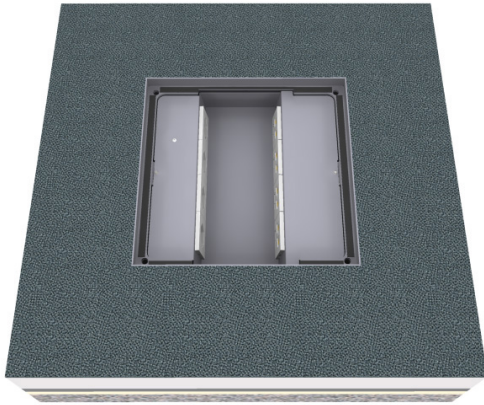

4x 1xT13 weiss

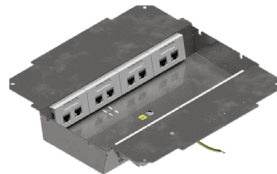

4x 2xRJ45

## Steckdoseneinsatz für 2x7 FLF ab 84mm, mit 5mm Vertiefung im Deckel

vertikal

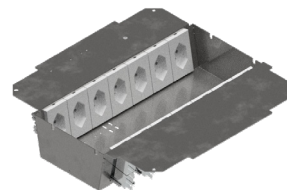
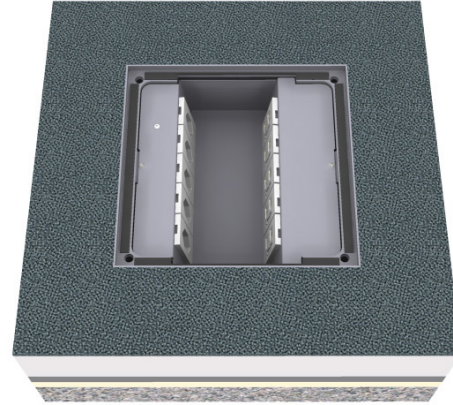

7x 1xT13 weiss

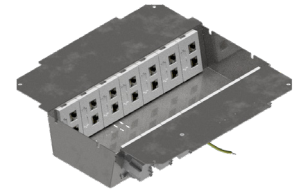

7x 2xRJ45



Steckdoseneinsatz für 2x4 FLF inkl.  
Erddraht, leer

UBD 320 325

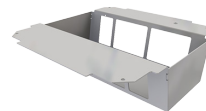

Steckdoseneinsatz für 2x7 FLF  
inkl. Erddraht, leer

UBD 320 326

## Modul 45x45



Steckdoseneinsatz mit 2x 6x  
45x45-Ausschnitten, leer

UBD 321 339

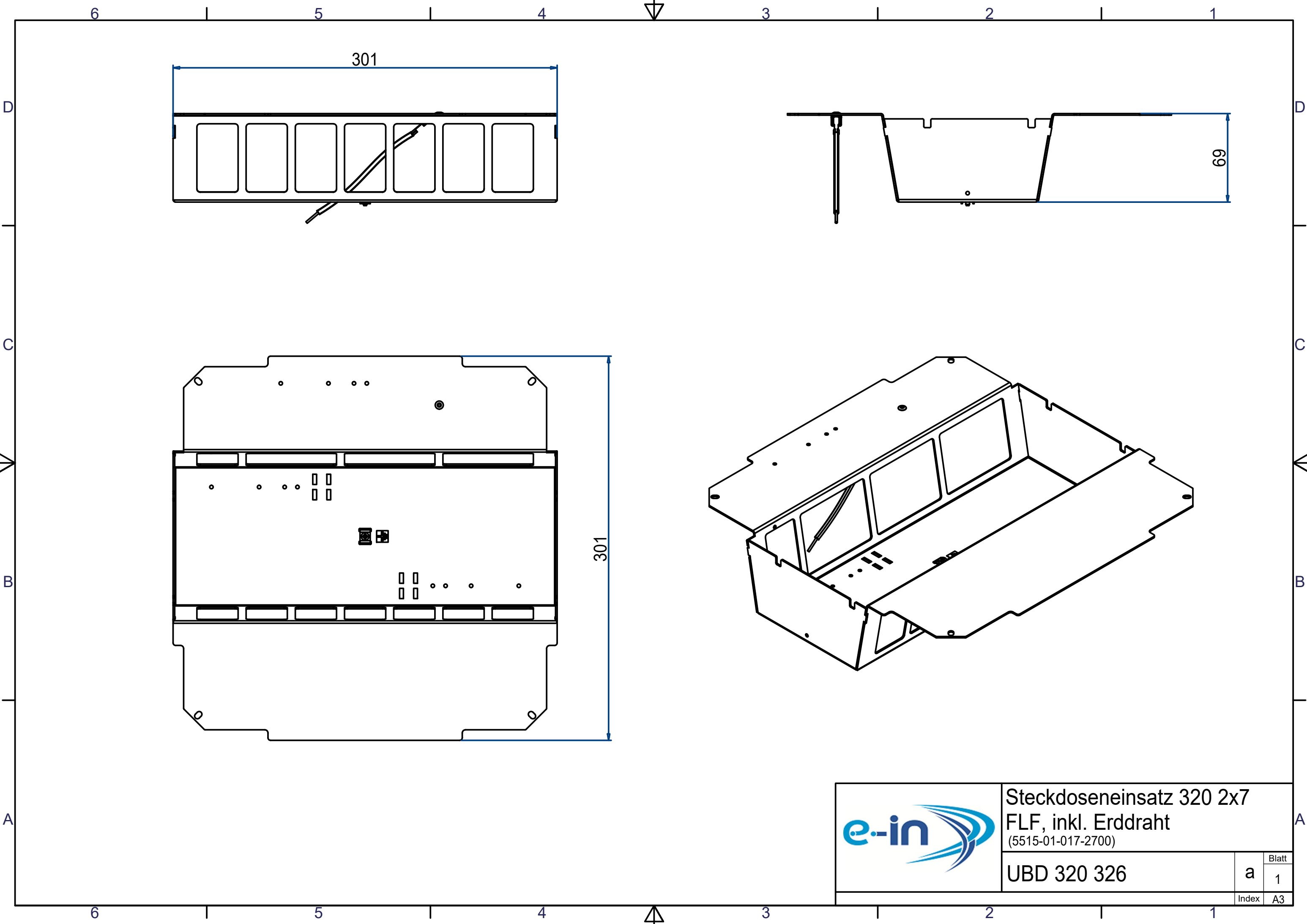



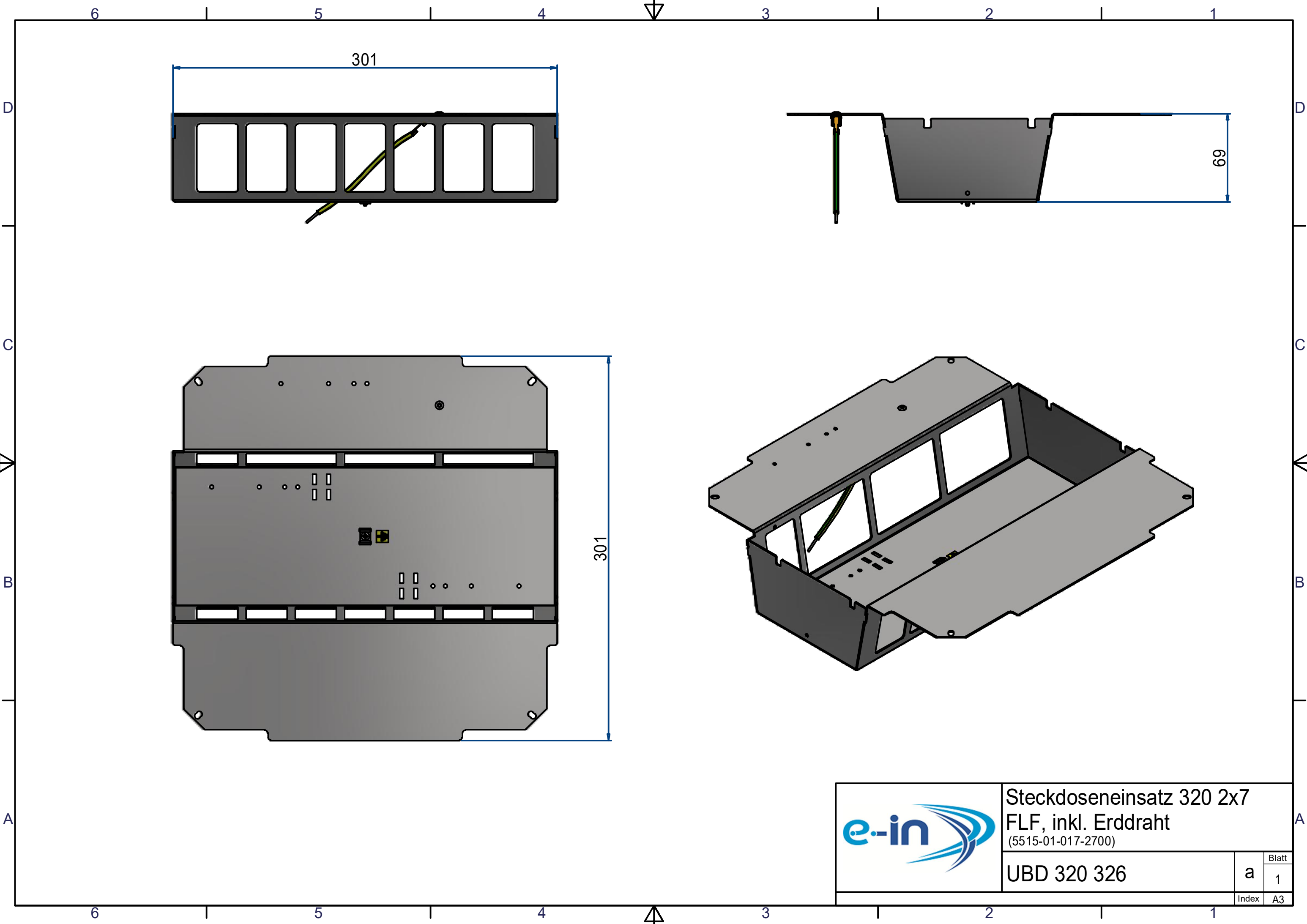



	<b>Steckdoseneinsatz 320 2x7</b> <b>FLF, inkl. Erddraht</b> (5515-01-017-2700)		Blatt
	<b>UBD 320 326</b>		1
		Index	A3

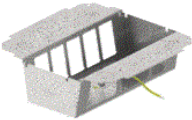

	<b>Steckdoseneinsatz 320 2x7</b> <b>FLF, inkl. Erddraht</b> (5515-01-017-2700)		Blatt
	<b>UBD 320 326</b>		1
		Index	A3

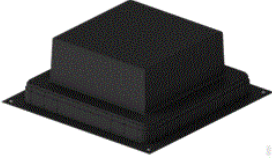

## Unterflur-Bodendose UBD 260 & UBD 320

↓ Benötigt		Optional ↓
<b>Steckdoseneinsatz</b>		
<b>Unterflur-Bodendose UBD</b>		
<b>Nivellierschrauben</b>		
		<b>Trittschall-Unterlage (optional)</b>
<b>Kunststoff-Einbaubox</b>		
		<b>Aufstockrahmen (optional)</b>

### Anmerkung

1. Etappe: Kunststoff-Einbaubox, Aufstockrahmen
2. Etappe: Unterflur-Bodendose UBD, Nivellierschrauben, Trittschall-Unterlage, Steckdoseneinsatz